Power Panel T-series

User's Manual

Version: **0.30 Preliminary (September 2014)**
Model no.: **MAPPT-ENG**

All information contained in this manual is current as of its creation/publication. B&R reserves the right to change the contents of this manual without notice. The information contained herein is believed to be accurate as of the date of publication; however, Bernecker + Rainer Industrie-Elektronik Ges.m.b.H. makes no warranty, expressed or implied, with regard to the products or documentation contained within this manual. In addition, Bernecker + Rainer Industrie-Elektronik Ges.m.b.H. shall not be liable for any incidental or consequential damages in connection with or arising from the furnishing, performance or use of the product(s) in this documentation. Software names, hardware names and trademarks are registered by their respective companies.

Chapter 1 General information.....	4
1 Manual history.....	4
2 Safety notices.....	4
2.1 Introduction.....	4
2.2 Intended use.....	4
2.3 Protection against electrostatic discharge.....	4
2.3.1 Packaging.....	5
2.3.2 Guidelines for proper ESD handling.....	5
2.4 Transport and storage.....	5
2.5 Installation.....	5
2.6 Operation.....	6
2.6.1 Protection against touching electrical parts.....	6
2.6.2 Environmental conditions - Dust, humidity, aggressive gases.....	6
2.6.3 Viruses and dangerous programs.....	6
2.7 Organization of safety notices.....	6
Chapter 2 T-Series.....	7
1 System features.....	7
1.1 Compact solution.....	7
1.2 Simple programming.....	7
1.3 Power Panel T30.....	7
1.4 Flexibility.....	8
1.5 Order number key.....	9
2 T-Series.....	10
2.1 Selecting a Power Panel.....	10
2.2 General technical data.....	10
2.3 Overview.....	11
2.3.1 Overview - 6PPT30.043x.....	11
2.3.2 Overview - 6PPT30.057x.....	11
2.3.3 Overview - 6PPT30.070x.....	11
2.3.4 Overview - 6PPT30.101x.....	12
2.3.5 Interfaces.....	12
2.4 6PPT30.xxxx-20x.....	13
2.4.1 6PPT30.043x-20x.....	13
2.4.2 6PPT30.057x-20x.....	16
2.4.3 6PPT30.070x-20x.....	19
2.4.4 6PPT30.101x-20x.....	22
2.4.5 Ethernet LEDs.....	25
2.4.6 Temperature/Humidity diagram.....	26
2.4.7 Connection elements.....	28
2.4.8 Dimensions.....	30
Chapter 3 Installation.....	38
1 Installation instructions.....	38
2 Mounting orientation.....	40
3 Grounding.....	40
4 Configuration - Possible operating modes.....	41
5 Touch screen calibration.....	41
Chapter 4 Standards and certifications.....	42
1 Applicable European directives.....	42
2 Overview of standards.....	42
3 International certifications.....	42
Chapter 5 Accessories.....	43
1 T-Series overview.....	43
2 TB102 2-pin power supply connector.....	44

2.1 Order data.....	44
2.2 Technical data.....	44
3 Data storage media.....	44
4 Cable accessories.....	44
Chapter 6 Maintenance.....	45
1 Cleaning.....	45
2 Screen burn-in on LCD/TFT monitors.....	45
Chapter 7 Technical information.....	46
1 Panel membrane.....	46
2 Viewing angles.....	46

Chapter 1 • General information

Information:

B&R keeps the printed version of user's manuals as current as possible. If a newer version of the user's manual is available, it can always be downloaded in electronic form (PDF) from the B&R website www.br-automation.com.

1 Manual history

Version	Date	Comment
0.10	August 2014	First edition
0.20	September 2014	Updated "Technical data" and "Connection elements"
0.30	September 2014	Updated "Technical data", "Temperature/Humidity diagram", "Installation instructions" & "Mounting orientation"

Table 1: Manual history

2 Safety notices

2.1 Introduction

Programmable logic controllers (PLCs), operating and monitoring devices (industrial PCs, Power Panels, Mobile Panels, etc.), as well as the B&R uninterruptible power supplies have been designed, developed or manufactured for conventional use in industry. They were not designed, developed and manufactured for any use involving serious risks or hazards that could lead to death, injury, serious physical damage or loss of any kind without the implementation of exceptionally stringent safety precautions. In particular, such risks and hazards include the use of these devices to monitor nuclear reactions in nuclear power plants, their use in flight control or flight safety systems as well as in the control of mass transportation systems, medical life support systems or weapons systems.

When using programmable logic controllers or operating/monitoring devices as control systems together with a Soft PLC (e.g. B&R Automation Runtime or comparable product) or Slot PLC (e.g. B&R LS251 or comparable product), safety precautions relevant to industrial control systems (e.g. the provision of safety devices such as emergency stop circuits, etc.) must be observed in accordance with applicable national and international regulations. The same applies for all other devices connected to the system, e.g. drives.

All tasks such as the installation, commissioning and servicing of devices are only permitted to be carried out by qualified personnel. Qualified personnel are those familiar with the transport, mounting, installation, commissioning and operation of devices who also have the appropriate qualifications (e.g. IEC 60364). National accident prevention regulations must be observed.

The safety notices, connection descriptions (type plate and documentation) and limit values listed in the technical data are to be read carefully before installation and commissioning and must be observed.

2.2 Intended use

Electronic devices are never completely failsafe. If the programmable control system, operating/monitoring device or uninterruptible power supply fails, the user is responsible for ensuring that other connected devices, e.g. motors, are brought to a secure state.

2.3 Protection against electrostatic discharge

Electrical components that can be damaged by electrostatic discharge (ESD) must be handled accordingly.

2.3.1 Packaging

- Electrical components with a housing
... do not require special ESD packaging, but must be handled properly (see "Electrical components with a housing" on page 5).
- Electrical components without a housing
...are protected by ESD-suitable packaging.

2.3.2 Guidelines for proper ESD handling

Electrical components with a housing

- Do not touch the contacts of connectors on the device (bus data contacts)
- Do not touch the connector contacts on connected cables.
- Do not touch the contact tips on circuit boards.

Electrical components without a housing

The following applies in addition to the points listed under "Electrical components with a housing":

- Any persons handling electrical components or devices with installed electrical components must be grounded.
- Components may only be touched on their narrow sides or front plate.
- Components should always be stored in a suitable medium (ESD packaging, conductive foam, etc.).
Information: Metallic surfaces are not suitable storage surfaces!
- Components should not be subjected to electrostatic discharge (e.g. through the use of charged plastics).
- Ensure a minimum distance of 10 cm from monitors and TV sets.
- Measurement devices and equipment must be grounded.
- Measurement probes on potential-free measurement devices must be discharged on sufficiently grounded surfaces before taking measurements.

Individual components

- ESD protective measures for individual components are thoroughly integrated at B&R (conductive floors, footwear, arm bands, etc.).
- These increased ESD protective measures for individual components are not necessary for customers handling B&R products.

2.4 Transport and storage

During transport and storage, devices must be protected against undue stress (mechanical loads, temperature, humidity, aggressive atmospheres, etc.).

Devices contain components sensitive to electrostatic charges that can be damaged by inappropriate handling. It is therefore necessary to provide the required protective measures against electrostatic discharge when installing or removing these devices (see "Protection against electrostatic discharge" on page 4).

2.5 Installation

- Installation must be performed according to this documentation using suitable equipment and tools.
- Devices may only be installed by qualified personnel without voltage applied.
- General safety guidelines and national accident prevention regulations must be observed.
- Electrical installation must be carried out according to applicable guidelines (e.g. line cross sections, fuses, protective ground connections).
- Take the necessary steps to protect against electrostatic discharges ().

2.6 Operation

2.6.1 Protection against touching electrical parts

To operate programmable logic controllers, operating/monitoring devices or uninterruptible power supplies, it is necessary for certain parts to carry dangerous voltage levels over 42 VDC. Touching one of these parts can result in a life-threatening electric shock. This could lead to death, severe injury or damage to equipment.

Before turning on the programmable logic controller, operating/monitoring devices or the uninterruptible power supply, the housing must be properly grounded (PE rail). Ground connections must be established even when testing or operating operating/monitoring devices or the uninterruptible power supply for a short time!

Before turning the device on, all parts that carry voltage must be securely covered. During operation, all covers must remain closed.

2.6.2 Environmental conditions - Dust, humidity, aggressive gases

The use of operating/monitoring devices (e.g. industrial PCs, Power Panels, Mobile Panels, etc.) and uninterruptible power supplies in very dusty environments should be avoided. Dust collection on the devices can affect functionality and may prevent sufficient cooling, especially in systems with active cooling systems (fans).

The presence of aggressive gases can also lead to malfunctions. When combined with high temperature and humidity, aggressive gases – e.g. with sulfur, nitrogen and chlorine components – can induce chemical reactions that can damage electronic components very quickly. Signs of the presence of aggressive gases are blackened copper surfaces and cable ends on existing equipment.

For operation in dusty or humid conditions, correctly installed (e.g. cutout installations) operating/monitoring devices like the Automation Panel or Power Panel are protected on the front. The back of all devices must be protected from dust and humidity and cleaned at suitable intervals.

2.6.3 Viruses and dangerous programs

This system is subject to potential risk each time data is exchanged or software is installed from a data medium (e.g. diskette, CD-ROM, USB flash drive, etc.), a network connection or the Internet. The user is responsible for assessing these dangers, implementing preventive measures such as virus protection programs, firewalls, etc. and making sure that software is only obtained from trusted sources.

2.7 Organization of safety notices

Safety notices in this manual are organized as follows:

Safety notice	Description
Danger!	Disregarding these safety guidelines and notices can be life-threatening.
Caution!	Disregarding these safety guidelines and notices can result in severe injury or substantial damage to equipment.
Warning!	Disregarding these safety guidelines and notices can result in injury or damage to equipment.
Information:	This information is important for preventing errors.

Table 2: Organization of safety notices

Chapter 2 • T-Series

1 System features

B&R has added the Power Panel T-Series to its Power Panel family. The Power Panel T30 terminal is equipped with an embedded browser and can even be used as a VNC client. The terminal series has 2 Ethernet and 2 USB interfaces, as well as various configuration options.



Figure 1: T-Series

1.1 Compact solution

Power Panels have an extremely compact design, minimal installation depth and an intelligent cable outlet arrangement, making them easy-to-mount space savers. And because they have no hard disks, fans or batteries, they are also maintenance-free. The panel front provides IP65 protection, which makes these devices extremely well-suited for harsh industrial environments.

1.2 Simple programming

Full integration of the HMI application in the Automation Studio automation software goes without saying. The same is true for programming in all of the IEC languages offered by B&R as well as Automation Basic and ANSI C.

1.3 Power Panel T30

The Power Panel T30 is purely a visualization device that can be operated in 2 different modes. On one hand, it operates as a web browser device using standard technology (frameless full screen mode). On the other hand, the terminal can also be used optimally with Visual Components.



Figure 2: Power Panel T30

1.4 Flexibility

The Power Panel T-Series is available in 4 different display sizes.

- 4.3" display
- 5.7" display
- 7.0" display
- 10.1" display

A touch button is integrated in the panel overlay at the lower right corner of the display. This element can be incorporated as an elegant feature of the HMI application for quick navigation or easy access to the home screen or help system.

The option to choose between portrait and landscape format adds even more flexibility to the machine layout. It is easy to switch between panel models depending on machine requirements. When it comes to color, users can select between two pinstripe options: anthracite gray or aluminum white.

Regardless of model, size and color, what all the devices have in common are a shallow installation depth and a minimized border width. Yet, even with the reduced dimensions, no compromises were made with regard to mounting stability or seal integrity.

2 T-Series

2.1 Selecting a Power Panel







Configuration	
<p>Display size</p> <p>The Power Panel T-Series is available in 4 different display sizes:</p> <p>4.3" variant 5.7" variant 7.0" variant 10.1" variant</p>	<p>4.3"</p>  <p>6PPT30.043x-20x</p> <p>5.7"</p>  <p>6PPT30.057x-20x</p> <p>7"</p>  <p>6PPT30.070x-20x</p> <p>10.1"</p>  <p>6PPT30.101x-20x</p>
<p>Resolution</p> <p>The option to choose between portrait and landscape format adds even more flexibility to the machine layout.</p>	<p>Landscape</p>  <p>6PPT30.043F-20x 6PPT30.0573-20x 6PPT30.0702-20x 6PPT30.101G-20x</p> <p>Portrait</p>  <p>6PPT30.043K-20x 6PPT30.057L-20x 6PPT30.070M-20x 6PPT30.101N-20x</p>
<p>Panel overlay</p> <p>The pinstripe design is available in aluminium white or anthracite gray.</p>	<p>Aluminium white pinstripe</p>  <p>6PPT30.043F-20W 6PPT30.0573-20W 6PPT30.043F-20W 6PPT30.057L-20W 6PPT30.0702-20W 6PPT30.101G-20W 6PPT30.070M-20W 6PPT30.101N-20W</p> <p>Anthracite gray pinstripe</p>  <p>6PPT30.043K-20B 6PPT30.0573-20B 6PPT30.043K-20B 6PPT30.057L-20B 6PPT30.0702-20B 6PPT30.101G-20B 6PPT30.070M-20B 6PPT30.101N-20B</p>

Figure 4: Selecting a Power Panel

2.2 General technical data

Name	Description
Processor	ARM Cortex A8 600 MHz
Memory	256 MB DDRAM
Interfaces	2 Ethernet interfaces 10/100BASE-T 2 USB 2.0 ports
Other	IP65 protection (front side) Temperature range from 0 to 50°C Fanless Power supply 8 to 32 VDC

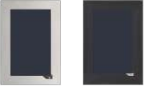
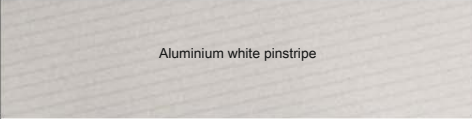
Table 3: Power Panel T-Series - General technical data

2.3 Overview

2.3.1 Overview - 6PPT30.043x





Model number	6PPT30.043F-20W	6PPT30.043F-20B	6PPT30.043K-20W	6PPT30.043K-20B
Figure				
Display	TFT color			
Resolution	WQVGA			
Display size	4.3"			
Touch screen	Analog resistive			
Format	Landscape		Portrait	
Color	Aluminum white	Anthracite	Aluminum white	Anthracite
Page	13			

Table 4: Overview - 6PPT30.043x

2.3.2 Overview - 6PPT30.057x

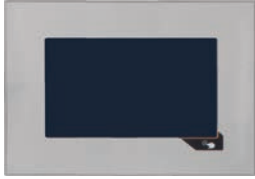

Model number	6PPT30.0573-20W	6PPT30.0573-20B	6PPT30.057L-20W	6PPT30.057L-20B
Figure				
Display	TFT color			
Resolution	VGA			
Display size	5.7"			
Touch screen	Analog resistive			
Format	Landscape		Portrait	
Color	Aluminum white	Anthracite	Aluminum white	Anthracite
Page	16			

Table 5: Overview - 6PPT30.057x

2.3.3 Overview - 6PPT30.070x

Model number	6PPT30.0702-20W	6PPT30.0702-20B	6PPT30.070M-20W	6PPT30.070M-20B
Figure				
Display	TFT color			

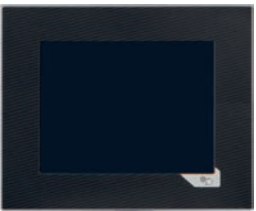
Table 6: Overview - 6PPT30.070x

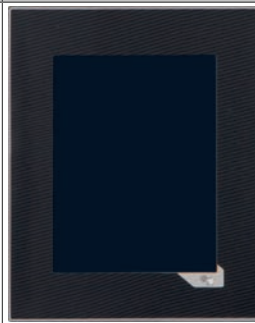
Model number	6PPT30.0702-20W	6PPT30.0702-20B	6PPT30.070M-20W	6PPT30.070M-20B
Resolution	WVGA			
Display size	7.0"			
Touch screen	Analog resistive			
Format	Landscape		Portrait	
Color	Aluminum white	Anthracite	Aluminum white	Anthracite
Page	19			

Table 6: Overview - 6PPT30.070x

2.3.4 Overview - 6PPT30.101x

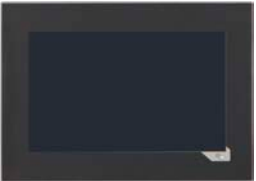
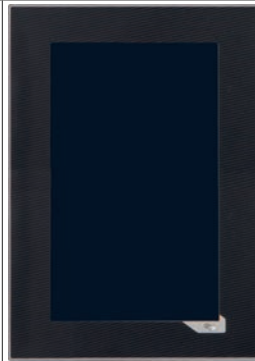

Model number	6PPT30.101G-20W	6PPT30.101G-20B	6PPT30.101N-20W	6PPT30.101N-20B
Figure				
Display	TFT color			
Resolution	WSVGA			
Display size	10.1"			
Touch screen	Analog resistive			
Format	Landscape		Portrait	
Color	Aluminum white	Anthracite	Aluminum white	Anthracite
Page	22			

Table 7: Overview - 6PPT30.101x

2.3.5 Interfaces

Model number	6PPT30.xxxx-20x
Figure	
Ethernet interfaces 10/100BASE-T	2
USB 2.0 interfaces	2

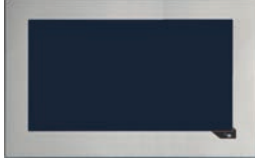
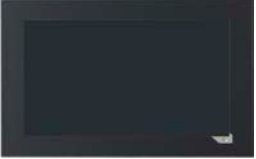
Table 8: Interfaces

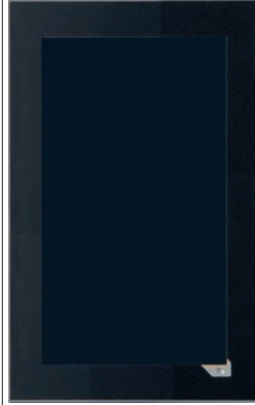
2.4 6PPT30.xxxx-20x

2.4.1 6PPT30.043x-20x

2.4.1.1 6PPT30.043x-20x - Order data

Model number	Short description	Figure
	T30	
6PPT30.043F-20W	Power Panel T30, 4.3", analog resistive touch screen, 2 Ethernet interfaces, internal switch, 2 USB 2.0 interfaces, embedded client software: - VNC client mode - Embedded web browser on board, landscape format, aluminum white pinstripe	
6PPT30.043F-20B	Power Panel T30, 4.3", analog resistive touch screen, 2 Ethernet interfaces, internal switch, 2 USB 2.0 interfaces, embedded client software: - VNC client mode - Embedded web browser on board, landscape format, anthracite gray pinstripe	
6PPT30.043K-20W	Power Panel T30, 4.3", analog resistive touch screen, 2 Ethernet interfaces, internal switch, 2 USB 2.0 interfaces, embedded client software: - VNC client mode - Embedded web browser on board, portrait format, aluminum white pinstripe	
6PPT30.043K-20B	Power Panel T30, 4.3", analog resistive touch screen, 2 Ethernet interfaces, internal switch, 2 USB 2.0 interfaces, embedded client software: - VNC client mode - Embedded web browser on board, portrait format, anthracite gray pinstripe	
	Required accessories	
	Terminal blocks	
0TB6102.2010-01	Accessory terminal block, 2-pin (3.81), screw clamp 1.5 mm ²	
0TB6102.2110-01	Accessory terminal block, 2-pin (3.81), cage clamp, 1.5 mm ²	
	USB accessories	
5MMUSB.2048-01	USB 2.0 flash drive, 2048 MB, B&R	
5MMUSB.4096-01	USB 2.0 flash drive, 4096 MB, B&R	

Table 9: 6PPT30.043F-20W, 6PPT30.043F-20B, 6PPT30.043K-20W, 6PPT30.043K-20B - Order data

2.4.1.2 6PPT30.043x-20x - Technical data

Product ID	6PPT30.043F-20W	6PPT30.043F-20B	6PPT30.043K-20W	6PPT30.043K-20B
General information				
Cooling	Fanless			
LEDs	Ethernet			
B&R ID code	0xE589	0xE58A	0xE58B	0xE58C
Power button	No			
Reset button	No			
Buzzer	Yes			
Electrical isolation				
24 VDC - USB	No			
USB - Ethernet	Yes			
Ethernet - 24 VDC	Yes			
Certification				
CE	Yes			
GOST-R	Yes			
Controller				
Operating system	T30 image			
DRAM	256 MB			
Real-time clock	No			
Processor				
Type	ARM Cortex A8			
Clock frequency	600 MHz			
L1 cache	64 kB			
L2 cache	256 kB			
Flash	512 MB			
Cooling	Passive			
Mode/Node switches	No			
Interfaces				
Switch				
Interface A	IF1 interface			
Interface B	IF2 interface			
IF1 interface				
Type	Ethernet			
Design	1x RJ45 shielded			
Cable length	Max. 100 m between 2 stations (segment length)			
Max. transfer rate	10/100 Mbit/s			
Transmission				
Physical interfaces	10BASE-T / 100BASE-TX			
Half-duplex	Yes			
Full-duplex	Yes			
Autonegotiation	Yes			
Auto-MDI / MDIX	Yes			
IF2 interface				
Type	Ethernet			
Design	1x RJ45 shielded			
Cable length	Max. 100 m between 2 stations (segment length)			
Max. transfer rate	10/100 Mbit/s			
Transmission				
Physical interfaces	10BASE-T / 100BASE-TX			
Half-duplex	Yes			
Full-duplex	Yes			
Autonegotiation	Yes			
Auto-MDI / MDIX	Yes			
IF3 interface				
Type	USB 2.0			
Design	Type A			
Current load	0.5 A			
IF4 interface				
Type	USB 2.0			
Design	Type A			
Current load	0.1 A			
Display				
Type	TFT color			
Display size	4.3"			
Colors	16.7 M			
Resolution	WQVGA, 480 x 272 pixels		WQVGA, 272 x 480 pixels	
Contrast	Typ. 350:1			
Viewing angles				
Horizontal	Direction R / Direction L = typ. 70°		Direction R = typ. 45° / Direction L = typ. 65°	
Vertical	Direction U = typ. 45° / Direction D = typ. 65°		Direction U / Direction D = typ. 70°	

Table 10: 6PPT30.043F-20W, 6PPT30.043F-20B, 6PPT30.043K-20W, 6PPT30.043K-20B - Technical data

Product ID	6PPT30.043F-20W	6PPT30.043F-20B	6PPT30.043K-20W	6PPT30.043K-20B
Backlight				
Classification	LED			
Brightness	Typ. 350 cd/m ²			
Half-brightness time ¹⁾	30.000 h			
Touch screen				
Type	AMT			
Technologies	Analog resistive			
Controller	B&R, 12-bit			
Transmittance	80% ±3%			
Screen rotation	Yes			
Electrical characteristics				
Nominal voltage	8 to 32 VDC			
Max. current at nominal voltage	230 mA			
Max. power consumption	5.5 W			
Operating conditions				
EN 60529 protection	Back: IP20 Front: IP65			
Environmental conditions				
Temperature				
Operation				
Horizontal installation	-20 to 60°C			
Vertical installation	-20 to 60°C			
Storage	-20 to 60°C			
Transport	-20 to 60°C			
Relative humidity				
Operation	See humidity diagram			
Storage	See humidity diagram			
Transport	See humidity diagram			
Mechanical characteristics				
Note	Order 1x 0TB6102.2010-01 and 1x 0TB6102.2110-01 terminal block separately			
Front				
Design	Aluminum white pinstripe	Anthracite gray pinstripe	Aluminum white pinstripe	Anthracite gray pinstripe
Dimensions				
Width	140 mm		96 mm	
Height	96 mm		140 mm	
Depth		38.3 mm		

Table 10: 6PPT30.043F-20W, 6PPT30.043F-20B, 6PPT30.043K-20W, 6PPT30.043K-20B - Technical data

- 1) At an ambient temperature of 25°C. Reducing the brightness by 50% can result in an approximately 50% increase in the half-brightness time.

2.4.2 6PPT30.057x-20x

2.4.2.1 6PPT30.057x-20x - Order data

Model number	Short description	Figure
	T30	
6PPT30.0573-20W	Power Panel T30, 5.7", analog resistive touch screen, 2 Ethernet interfaces, internal switch, 2 USB 2.0 interfaces, embedded client software: - VNC client mode - Embedded web browser on board, landscape format, aluminum white pinstripe	
6PPT30.0573-20B	Power Panel T30, 5.7", analog resistive touch screen, 2 Ethernet interfaces, internal switch, 2 USB 2.0 interfaces, embedded client software: - VNC client mode - Embedded web browser on board, landscape format, anthracite gray pinstripe	
6PPT30.057L-20W	Power Panel T30, 5.7", analog resistive touch screen, 2 Ethernet interfaces, internal switch, 2 USB 2.0 interfaces, embedded client software: - VNC client mode - Embedded web browser on board, portrait format, aluminum white pinstripe	
6PPT30.057L-20B	Power Panel T30, 5.7", analog resistive touch screen, 2 Ethernet interfaces, internal switch, 2 USB 2.0 interfaces, embedded client software: - VNC client mode - Embedded web browser on board, portrait format, anthracite gray pinstripe	
	Required accessories	
	Terminal blocks	
0TB6102.2010-01	Accessory terminal block, 2-pin (3.81), screw clamp 1.5 mm ²	
0TB6102.2110-01	Accessory terminal block, 2-pin (3.81), cage clamp, 1.5 mm ²	
	USB accessories	
5MMUSB.2048-01	USB 2.0 flash drive, 2048 MB, B&R	
5MMUSB.4096-01	USB 2.0 flash drive, 4096 MB, B&R	

Table 11: 6PPT30.0573-20W, 6PPT30.0573-20B, 6PPT30.057L-20W, 6PPT30.057L-20B - Order data

2.4.2.2 6PPT30.057x-20x - Technical data

Product ID	6PPT30.0573-20W	6PPT30.0573-20B	6PPT30.057L-20W	6PPT30.057L-20B
General information				
Cooling	Fanless			
LEDs	Ethernet			
B&R ID code	0xE58D	0xE58E	0xE58F	0xE590
Power button	No			
Reset button	No			
Buzzer	Yes			
Electrical isolation				
24 VDC - USB	No			
USB - Ethernet	Yes			
Ethernet - 24 VDC	Yes			
Certification				
CE	Yes			
GOST-R	Yes			
Controller				
Operating system	T30 image			
DRAM	256 MB			
Real-time clock	No			
Processor				
Type	ARM Cortex A8			
Clock frequency	600 MHz			
L1 cache	64 kB			
L2 cache	256 kB			
Flash	512 MB			
Cooling	Passive			
Mode/Node switches	No			
Interfaces				
Switch				
Interface A	IF1 interface			
Interface B	IF2 interface			
IF1 interface				
Type	Ethernet			
Design	1x RJ45 shielded			
Cable length	Max. 100 m between 2 stations (segment length)			
Max. transfer rate	10/100 Mbit/s			
Transmission				
Physical interfaces	10BASE-T / 100BASE-TX			
Half-duplex	Yes			
Full-duplex	Yes			
Autonegotiation	Yes			
Auto-MDI / MDIX	Yes			
IF2 interface				
Type	Ethernet			
Design	1x RJ45 shielded			
Cable length	Max. 100 m between 2 stations (segment length)			
Max. transfer rate	10/100 Mbit/s			
Transmission				
Physical interfaces	10BASE-T / 100BASE-TX			
Half-duplex	Yes			
Full-duplex	Yes			
Autonegotiation	Yes			
Auto-MDI / MDIX	Yes			
IF3 interface				
Type	USB 2.0			
Design	Type A			
Current load	0.5 A			
IF4 interface				
Type	USB 2.0			
Design	Type A			
Current load	0.1 A			
Display				
Type	TFT color			
Display size	5.7"			
Colors	262,000			
Resolution	VGA, 640 x 480 pixels		VGA, 480 x 640 pixels	
Contrast	Typ. 850:1			
Viewing angles				
Horizontal	Direction R / Direction L = typ. 80°			
Vertical	Direction U / Direction D = typ. 80°			

Table 12: 6PPT30.0573-20W, 6PPT30.0573-20B, 6PPT30.057L-20W, 6PPT30.057L-20B - Technical data

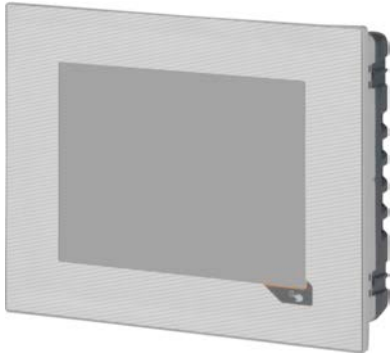
Product ID	6PPT30.0573-20W	6PPT30.0573-20B	6PPT30.057L-20W	6PPT30.057L-20B
Backlight				
Classification	LED			
Brightness	Typ. 400 cd/m ²			
Half-brightness time ¹⁾	50,000 h			
Touch screen				
Type	AMT			
Technologies	Analog resistive			
Controller	B&R, 12-bit			
Transmittance	80% ±3%			
Screen rotation	Yes			
Electrical characteristics				
Nominal voltage	8 to 32 VDC			
Max. current at nominal voltage	319 mA			
Max. power consumption	7.66 W			
Operating conditions				
EN 60529 protection	Back: IP20 Front: IP65			
Environmental conditions				
Temperature				
Operation				
Horizontal installation	-20 to 60°C			
Vertical installation	-20 to 60°C			
Storage	-20 to 60°C			
Transport	-20 to 60°C			
Relative humidity				
Operation	See humidity diagram			
Storage	See humidity diagram			
Transport	See humidity diagram			
Mechanical characteristics				
Note	Order 1x 0TB6102.2010-01 and 1x 0TB6102.2110-01 terminal block separately			
Front				
Design	Aluminum white pinstripe	Anthracite gray pinstripe	Aluminum white pinstripe	Anthracite gray pinstripe
Dimensions				
Width	172 mm		140 mm	
Height	140 mm		172 mm	
Depth		48 mm		

Table 12: 6PPT30.0573-20W, 6PPT30.0573-20B, 6PPT30.057L-20W, 6PPT30.057L-20B - Technical data

1) At an ambient temperature of 25°C. Reducing the brightness by 50% can typically result in an approximately 50% increase in the half-brightness time.

2.4.3 6PPT30.070x-20x

2.4.3.1 6PPT30.070x-20x - Order data

Model number	Short description	Figure
	T30	
6PPT30.0702-20W	Power Panel T30, 7", analog resistive touch screen, 2 Ethernet interfaces, internal switch, 2 USB 2.0 interfaces, embedded client software: - VNC client mode - Embedded web browser on board, landscape format, aluminum white pinstripe	
6PPT30.0702-20B	Power Panel T30, 7", analog resistive touch screen, 2 Ethernet interfaces, internal switch, 2 USB 2.0 interfaces, embedded client software: - VNC client mode - Embedded web browser on board, landscape format, anthracite gray pinstripe	
6PPT30.070M-20W	Power Panel T30, 7", analog resistive touch screen, 2 Ethernet interfaces, internal switch, 2 USB 2.0 interfaces, embedded client software: - VNC client mode - Embedded web browser on board, portrait format, aluminum white pinstripe	
6PPT30.070M-20B	Power Panel T30, 7", analog resistive touch screen, 2 Ethernet interfaces, internal switch, 2 USB 2.0 interfaces, embedded client software: - VNC client mode - Embedded web browser on board, portrait format, anthracite gray pinstripe	
	Required accessories	
	Terminal blocks	
0TB6102.2010-01	Accessory terminal block, 2-pin (3.81), screw clamp 1.5 mm ²	
0TB6102.2110-01	Accessory terminal block, 2-pin (3.81), cage clamp, 1.5 mm ²	
	USB accessories	
5MMUSB.2048-01	USB 2.0 flash drive, 2048 MB, B&R	
5MMUSB.4096-01	USB 2.0 flash drive, 4096 MB, B&R	

Table 13: 6PPT30.0702-20W, 6PPT30.0702-20B, 6PPT30.070M-20W, 6PPT30.070M-20B - Order data

2.4.3.2 6PPT30.070x-20x - Technical data

Product ID	6PPT30.0702-20W	6PPT30.0702-20B	6PPT30.070M-20W	6PPT30.070M-20B
General information				
Cooling	Fanless			
LEDs	Ethernet			
B&R ID code	0xE591	0xE592	0xE593	0xE594
Power button	No			
Reset button	No			
Buzzer	Yes			
Electrical isolation				
24 VDC - USB	No			
USB - Ethernet	Yes			
Ethernet - 24 VDC	Yes			
Certification				
CE	Yes			
GOST-R	Yes			
Controller				
Operating system	T30 image			
DRAM	256 MB			
Real-time clock	No			
Processor				
Type	ARM Cortex A8			
Clock frequency	600 MHz			
L1 cache	64 kB			
L2 cache	256 kB			
Flash	512 MB			
Cooling	Passive			
Mode/Node switches	No			
Interfaces				
Switch				
Interface A	IF1 interface			
Interface B	IF2 interface			
IF1 interface				
Type	Ethernet			
Design	1x RJ45 shielded			
Cable length	Max. 100 m between 2 stations (segment length)			
Max. transfer rate	10/100 Mbit/s			
Transmission				
Physical interfaces	10BASE-T / 100BASE-TX			
Half-duplex	Yes			
Full-duplex	Yes			
Autonegotiation	Yes			
Auto-MDI / MDIX	Yes			
IF2 interface				
Type	Ethernet			
Design	1x RJ45 shielded			
Cable length	Max. 100 m between 2 stations (segment length)			
Max. transfer rate	10/100 Mbit/s			
Transmission				
Physical interfaces	10BASE-T / 100BASE-TX			
Half-duplex	Yes			
Full-duplex	Yes			
Autonegotiation	Yes			
Auto-MDI / MDIX	Yes			
IF3 interface				
Type	USB 2.0			
Design	Type A			
Current load	0.5 A			
IF4 interface				
Type	USB 2.0			
Design	Type A			
Current load	0.1 A			
Display				
Type	TFT color			
Display size	7"			
Colors	16.2 M			
Resolution	WVGA, 800 x 480 pixels		WVGA, 480 x 800 pixels	
Contrast	Typ. 600:1			
Viewing angles				
Horizontal	Direction R / Direction L = typ. 60°		Direction R / Direction L = typ. 70°	
Vertical	Direction U / Direction D = typ. 70°		Direction U / Direction D = typ. 60°	

Table 14: 6PPT30.0702-20W, 6PPT30.0702-20B, 6PPT30.070M-20W, 6PPT30.070M-20B - Technical data

Product ID	6PPT30.0702-20W	6PPT30.0702-20B	6PPT30.070M-20W	6PPT30.070M-20B
Backlight				
Classification	LED			
Brightness	Typ. 500 cd/m ²			
Half-brightness time ¹⁾	50,000 h			
Touch screen				
Type	AMT			
Technologies	Analog resistive			
Controller	B&R, 12-bit			
Transmittance	80% ±3%			
Screen rotation	Yes			
Electrical characteristics				
Nominal voltage	8 to 32 VDC			
Max. current at nominal voltage	389 mA			
Max. power consumption	9.34 W			
Operating conditions				
EN 60529 protection	Back: IP20 Front: IP65			
Environmental conditions				
Temperature				
Operation				
Horizontal installation	-20 to 60°C			
Vertical installation	-20 to 60°C			
Storage	-20 to 60°C			
Transport	-20 to 60°C			
Relative humidity				
Operation	See humidity diagram			
Storage	See humidity diagram			
Transport	See humidity diagram			
Mechanical characteristics				
Note	Order 1x 0TB6102.2010-01 and 1x 0TB6102.2110-01 terminal block separately			-
Front				
Design	Aluminum white pinstripe	Anthracite gray pinstripe	Aluminum white pinstripe	Anthracite gray pinstripe
Dimensions				
Width	197 mm		140 mm	
Height	140 mm		197 mm	
Depth		48 mm		

Table 14: 6PPT30.0702-20W, 6PPT30.0702-20B, 6PPT30.070M-20W, 6PPT30.070M-20B - Technical data

1) At an ambient temperature of 25°C.

2.4.4 6PPT30.101x-20x

2.4.4.1 6PPT30.101x-20x - Order data

Model number	Short description	Figure
	T30	
6PPT30.101G-20W	Power Panel T30, 10.1", analog resistive touch screen, 2 Ethernet interfaces, internal switch, 2 USB 2.0 interfaces, embedded client software: - VNC client mode - Embedded web browser on board, landscape format, aluminum white pinstripe	
6PPT30.101G-20B	Power Panel T30, 10.1", analog resistive touch screen, 2 Ethernet interfaces, internal switch, 2 USB 2.0 interfaces, embedded client software: - VNC client mode - Embedded web browser on board, landscape format, anthracite gray pinstripe	
6PPT30.101N-20W	Power Panel T30, 10.1", analog resistive touch screen, 2 Ethernet interfaces, internal switch, 2 USB 2.0 interfaces, embedded client software: - VNC client mode - Embedded web browser on board, portrait format, aluminum white pinstripe	
6PPT30.101N-20B	Power Panel T30, 10.1", analog resistive touch screen, 2 Ethernet interfaces, internal switch, 2 USB 2.0 interfaces, embedded client software: - VNC client mode - Embedded web browser on board, portrait format, anthracite gray pinstripe	
	Required accessories	
	Terminal blocks	
0TB6102.2010-01	Accessory terminal block, 2-pin (3.81), screw clamp 1.5 mm ²	
0TB6102.2110-01	Accessory terminal block, 2-pin (3.81), cage clamp, 1.5 mm ²	
	USB accessories	
5MMUSB.2048-01	USB 2.0 flash drive, 2048 MB, B&R	
5MMUSB.4096-01	USB 2.0 flash drive, 4096 MB, B&R	

Table 15: 6PPT30.101G-20W, 6PPT30.101G-20B, 6PPT30.101N-20W, 6PPT30.101N-20B - Order data

2.4.4.2 6PPT30.101x-20x - Technical data

Product ID	6PPT30.101G-20W	6PPT30.101G-20B	6PPT30.101N-20W	6PPT30.101N-20B
General information				
Cooling	Fanless			
LEDs	Ethernet			
B&R ID code	0xE595	0xE596	0xE597	0xE598
Power button	No			
Reset button	No			
Buzzer	Yes			
Electrical isolation				
24 VDC - USB	No			
USB - Ethernet	Yes			
Ethernet - 24 VDC	Yes			
Certification				
CE	Yes			
GOST-R	Yes			
Controller				
Operating system	T30 image			
DRAM	256 MB			
Real-time clock	No			
Processor				
Type	ARM Cortex A8			
Clock frequency	600 MHz			
L1 cache	64 kB			
L2 cache	256 kB			
Flash	512 MB			
Cooling	Passive			
Mode/Node switches	No			
Interfaces				
Switch				
Interface A	IF1 interface			
Interface B	IF2 interface			
IF1 interface				
Type	Ethernet			
Design	1x RJ45 shielded			
Cable length	Max. 100 m between 2 stations (segment length)			
Max. transfer rate	10/100 Mbit/s			
Transmission				
Physical interfaces	10BASE-T / 100BASE-TX			
Half-duplex	Yes			
Full-duplex	Yes			
Autonegotiation	Yes			
Auto-MDI / MDIX	Yes			
IF2 interface				
Type	Ethernet			
Design	1x RJ45 shielded			
Cable length	Max. 100 m between 2 stations (segment length)			
Max. transfer rate	10/100 Mbit/s			
Transmission				
Physical interfaces	10BASE-T / 100BASE-TX			
Half-duplex	Yes			
Full-duplex	Yes			
Autonegotiation	Yes			
Auto-MDI / MDIX	Yes			
IF3 interface				
Type	USB 2.0			
Design	Type A			
Current load	0.5 A			
IF4 interface				
Type	USB 2.0			
Design	Type A			
Current load	0.1 A			
Display				
Type	TFT color			
Display size	10.1"			
Colors	256 k			
Resolution	WSVGA, 1024 x 600 pixels		WSVGA, 600 x 1024 pixels	
Contrast	Typ. 500:1			
Viewing angles				
Horizontal	Direction R / Direction L = typ. 80°			
Vertical	Direction U / Direction D = typ. 80°			

Table 16: 6PPT30.101G-20W, 6PPT30.101G-20B, 6PPT30.101N-20W, 6PPT30.101N-20B - Technical data

Product ID	6PPT30.101G-20W	6PPT30.101G-20B	6PPT30.101N-20W	6PPT30.101N-20B
Backlight				
Classification	LED			
Brightness	Typ. 500 cd/m ²			
Half-brightness time ¹⁾	50,000 h			
Touch screen				
Type	AMT			
Technologies	Analog resistive			
Controller	B&R, 12-bit			
Transmittance	80% ±3%			
Screen rotation	Yes			
Electrical characteristics				
Nominal voltage	8 to 32 VDC			
Max. current at nominal voltage	429 mA			
Max. power consumption	10.3 W			
Operating conditions				
EN 60529 protection	Back: IP20 Front: IP65			
Environmental conditions				
Temperature				
Operation				
Horizontal installation	-20 to 60°C			
Vertical installation	-20 to 60°C			
Storage	-20 to 60°C			
Transport	-20 to 60°C			
Relative humidity				
Operation	See humidity diagram			
Storage	See humidity diagram			
Transport	See humidity diagram			
Mechanical characteristics				
Note	Order 1x 0TB6102.2010-01 and 1x 0TB6102.2110-01 terminal block separately			
Front				
Design	Aluminum white pinstripe	Anthracite gray pinstripe	Aluminum white pinstripe	Anthracite gray pinstripe
Dimensions				
Width	276 mm		172 mm	
Height	172 mm		276 mm	
Depth		48 mm		

Table 16: 6PPT30.101G-20W, 6PPT30.101G-20B, 6PPT30.101N-20W, 6PPT30.101N-20B - Technical data

1) At an ambient temperature of 25°C.

2.4.5 Ethernet LEDs

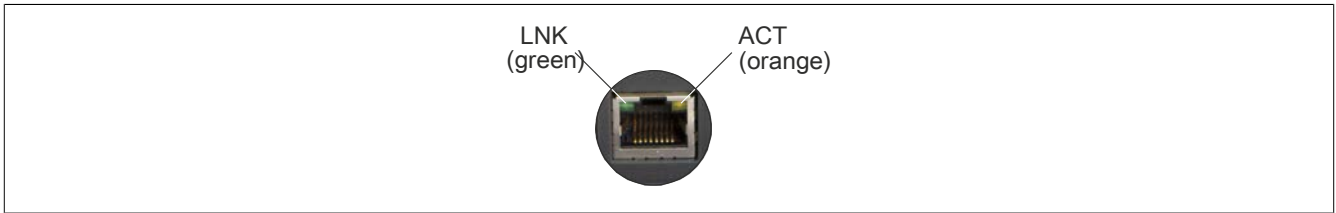

Figure 5: Ethernet and POWERLINK LEDs

LED	Color	Status	Description
ACT	Orange	On	No Ethernet activity on the bus
		Blinking	Ethernet activity on the bus
LNK	Green	On	Link established to the remote station

Table 17: Ethernet LEDs

2.4.6 Temperature/Humidity diagram

6PPT30.043x-20x

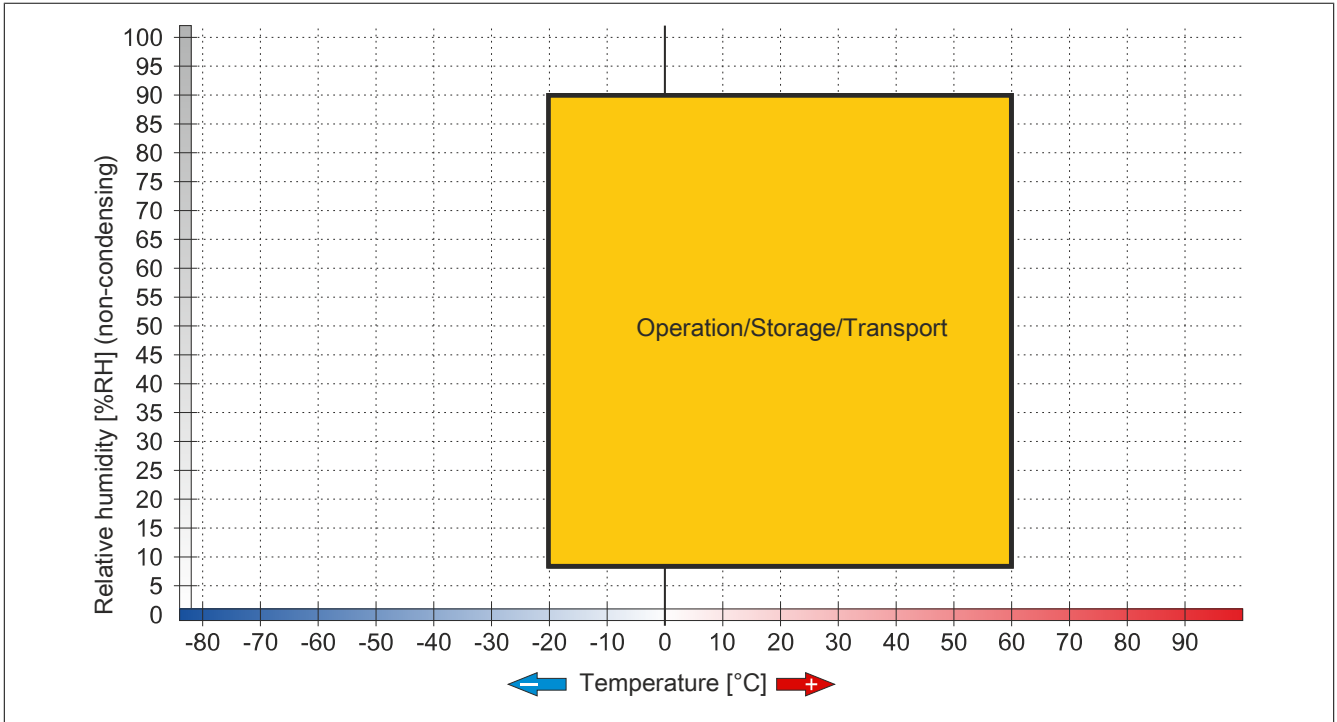

Figure 6: 6PPT30.043x-20x - Temperature/Humidity diagram

6PPT30.057x-20x

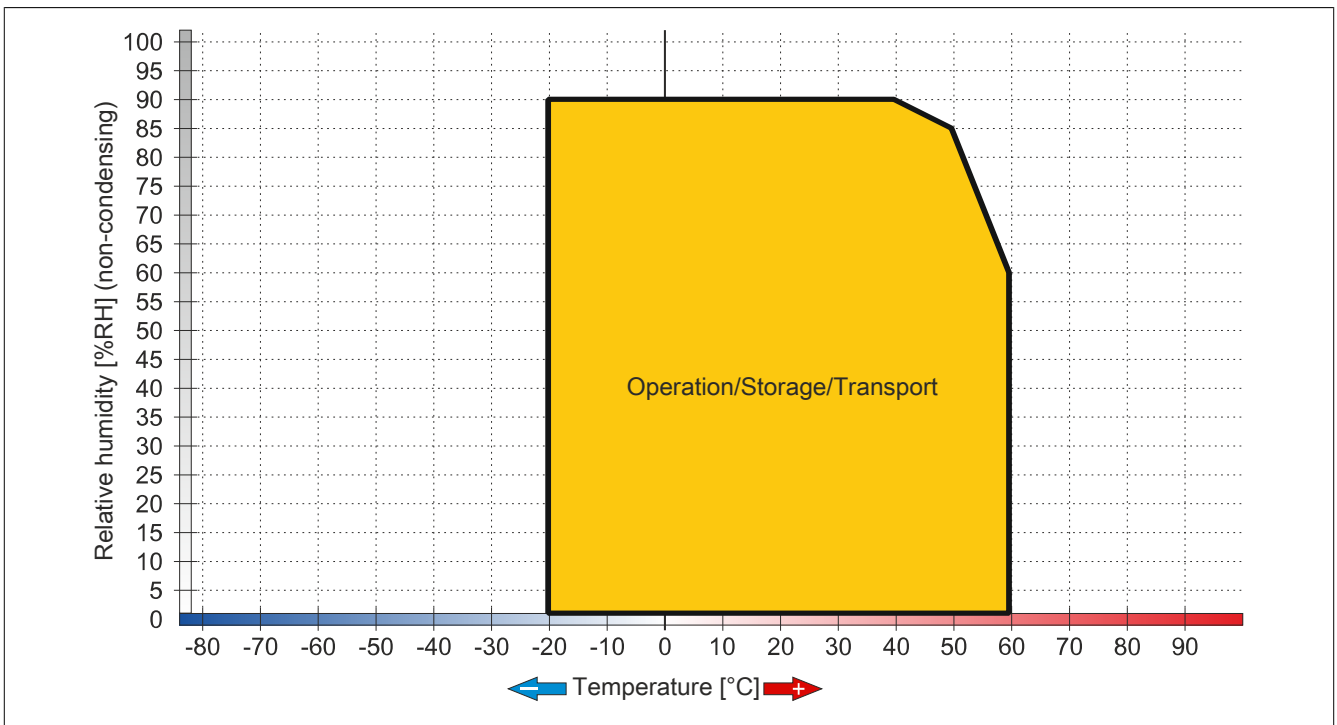

Figure 7: 6PPT30.057x-20x - Temperature/Humidity diagram

6PPT30.070x-20x

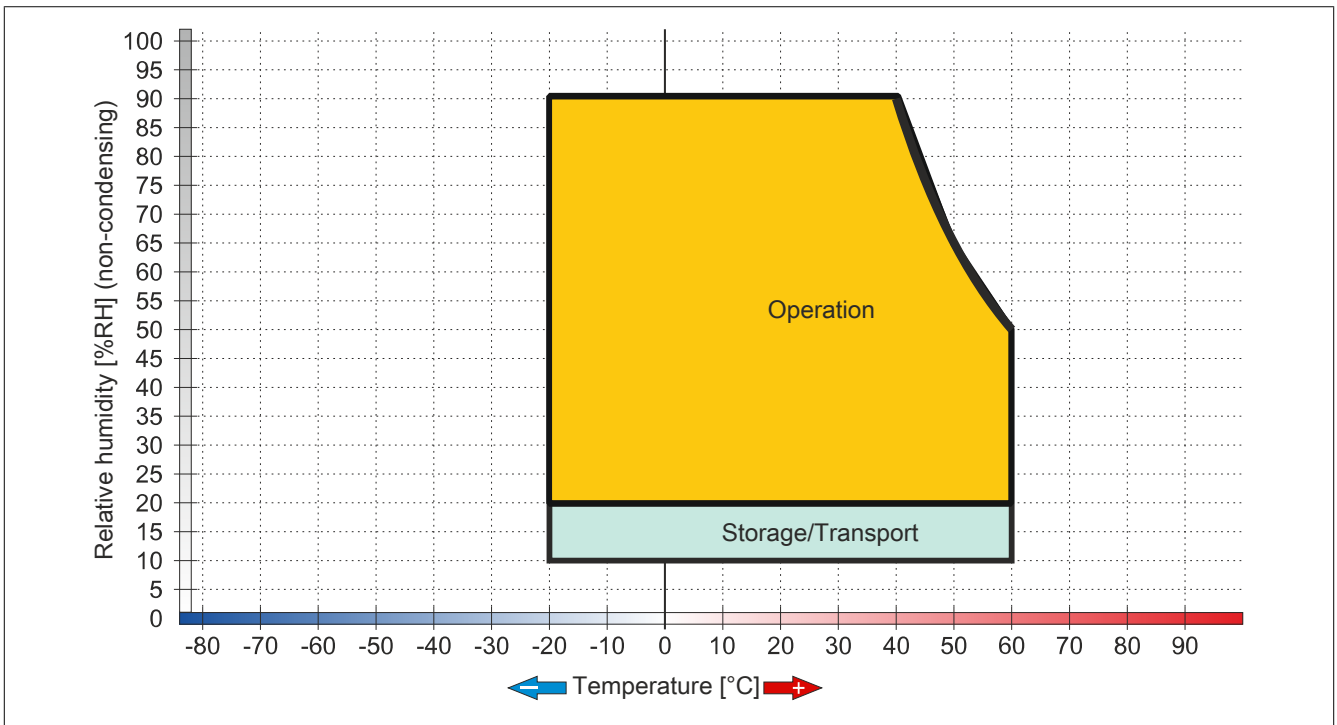

Figure 8: 6PPT30.070x-20x - Temperature/Humidity diagram

6PPT30.101x-20x

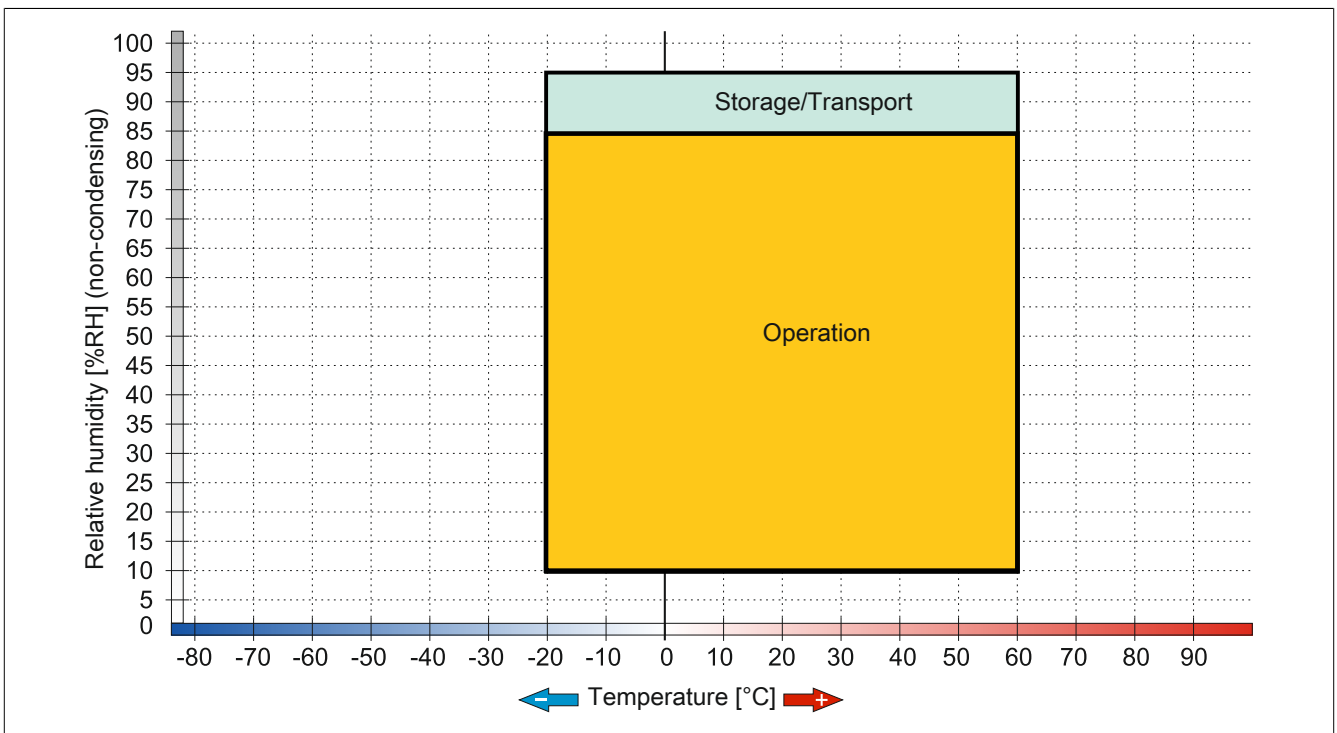

Figure 9: 6PPT30.101x-20x - Temperature/Humidity diagram

2.4.7 Connection elements

2.4.7.1 Ethernet interface

Interface	Pinout		
	Terminal	Ethernet	
Ethernet interface  RJ45 shielded (10BASE-T /100BASE-TX)	1	RXD	Receive signal
	2	RXD\	Receive signal inverted
	3	TXD	Transmit signal
	4	Termination	Termination
	5	Termination	Termination
	6	TXD\	Transmit signal inverted
	7	Termination	Termination
	8	Termination	Termination

Table 18: Ethernet interface - Pinout

2.4.7.2 USB port

This Power Panel features a USB 2.0 (Universal Serial Bus) host controller with 2 USB ports that are accessible externally for the user.



Figure 10: USB port

USB port	
Transfer rate ¹	Low speed (1.5 Mbit/s), full speed (12 Mbit/s), high speed (480 Mbit/s)
Power supply	Max. 0.5 A (IF3) or 0.1 A (IF4) per interface ²

Table 19: USB port

¹ The actual value depends on the operating system or driver being used.

² Each USB port is protected by a maintenance-free "USB current-limiting circuit breaker" (max. 0.5 A @ IF3 / max. 0.1 A @ IF4).

Warning!

Peripheral USB devices can be connected to the USB ports on this device. Due to the vast number of USB devices available on the market, B&R cannot guarantee their performance.

Important!

Because this interface is designed according to general PC specifications, extreme care should be exercised with regard to EMC, cable routing, etc.

2.4.7.3 Power supply



Figure 11: Power supply

The pinout is listed in the following table and printed on the back of the Power Panel. The Power Panel has reverse polarity protection that prevents the supply voltage from being connected incorrectly and damaging the device. Overload protection must be provided by an external fuse (TBD A, fast-acting).

Pinout		
Terminal		Assignment
1	+	24 VDC
2	-	GND
Required accessories		
0TB6102.2010-01	Accessory terminal block, 2-pin (3.81), screw clamp 1.5 mm ²	
0TB6102.2110-01	Accessory terminal block, 2-pin (3.81), cage clamp, 1.5 mm ²	

Table 20: Power supply

Important!

The ground potential (which has a spade terminal) must be connected to ground (e.g. control cabinet) using the shortest possible path.



Figure 12: Grounding

2.4.8 Dimensions

2.4.8.1 Dimensions - 6PPT30.043x-20x

Landscape

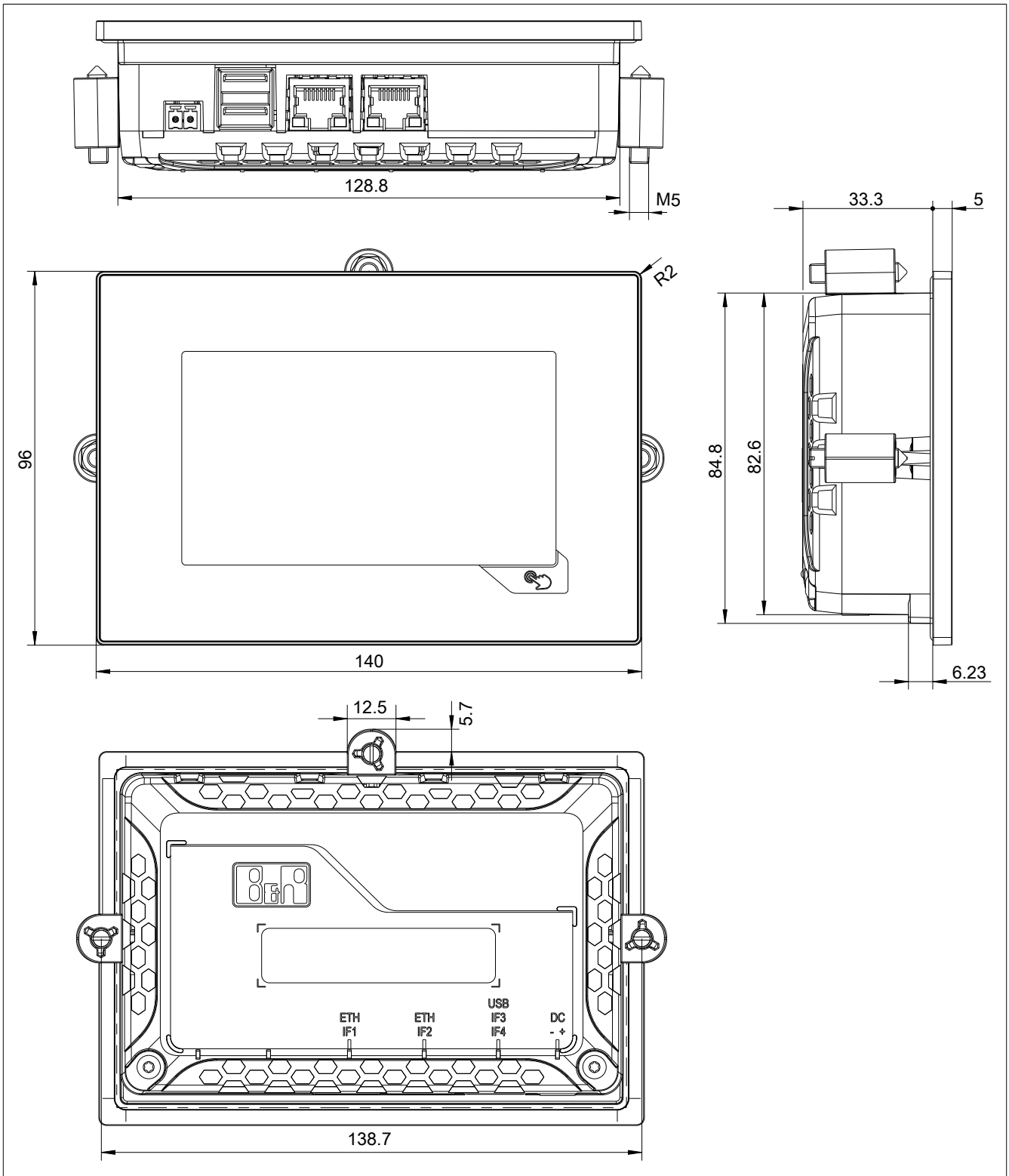

Figure 13: Dimensions - 6PPT30.043x-20x - 6PPT30.043F

Max. control cabinet thickness: 6 mm

Cutout dimensions: 130.8 mm \pm 1 x 86.8 mm \pm 1

Portrait

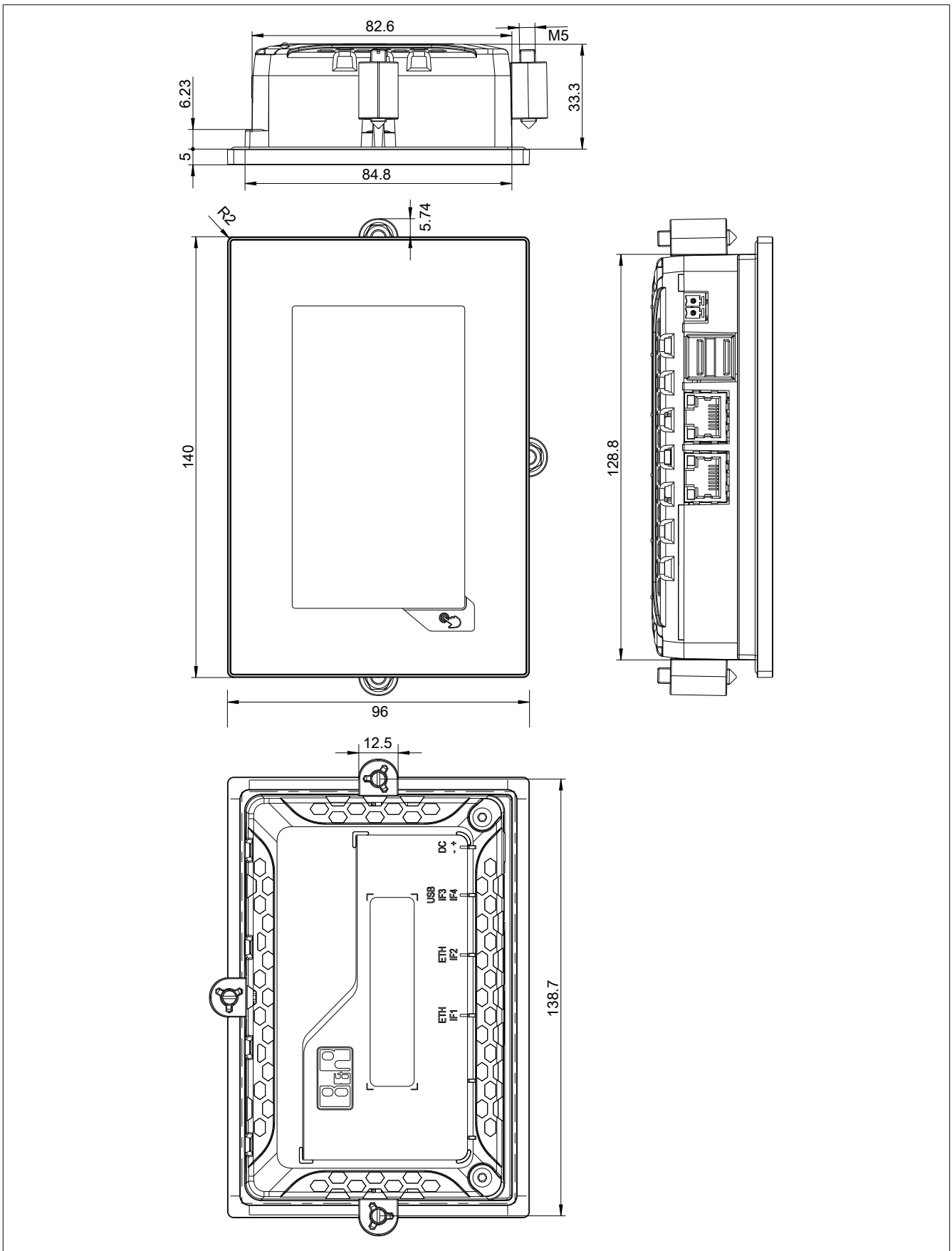

Figure 14: Dimensions - 6PPT30.043x-20x - 6PPT30.043K

Max. control cabinet thickness: 6 mm

Cutout dimensions: 86.8 mm \pm 1 x 130.8 mm \pm 1

2.4.8.2 Dimensions - 6PPT30.057x-20x

Landscape

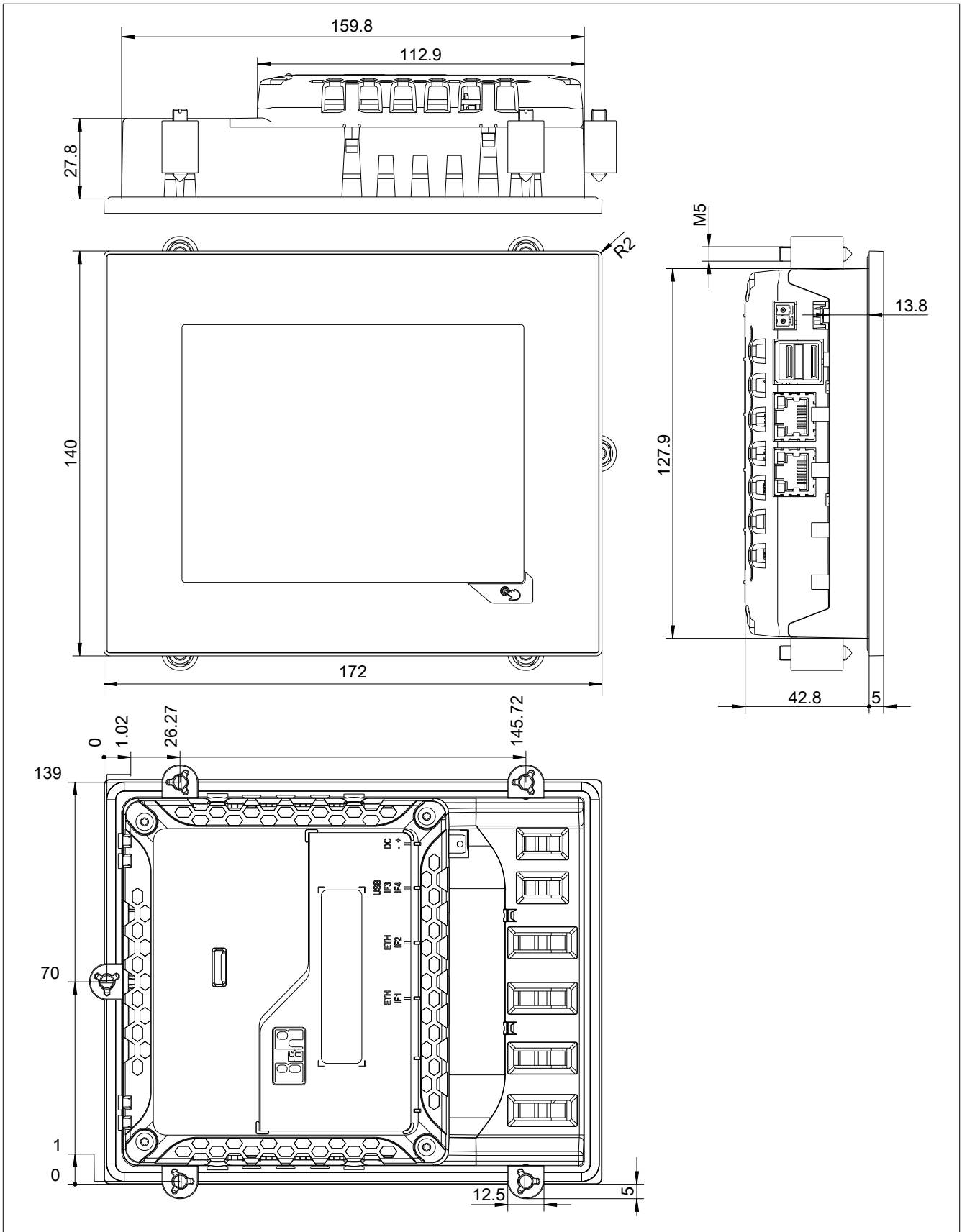

Figure 15: Dimensions - 6PPT30.057x-20x - 6PPT30.0573

Max. control cabinet thickness: 6 mm

Cutout dimensions: 161.8 mm ±1 x 129.9 mm ±1

Portrait

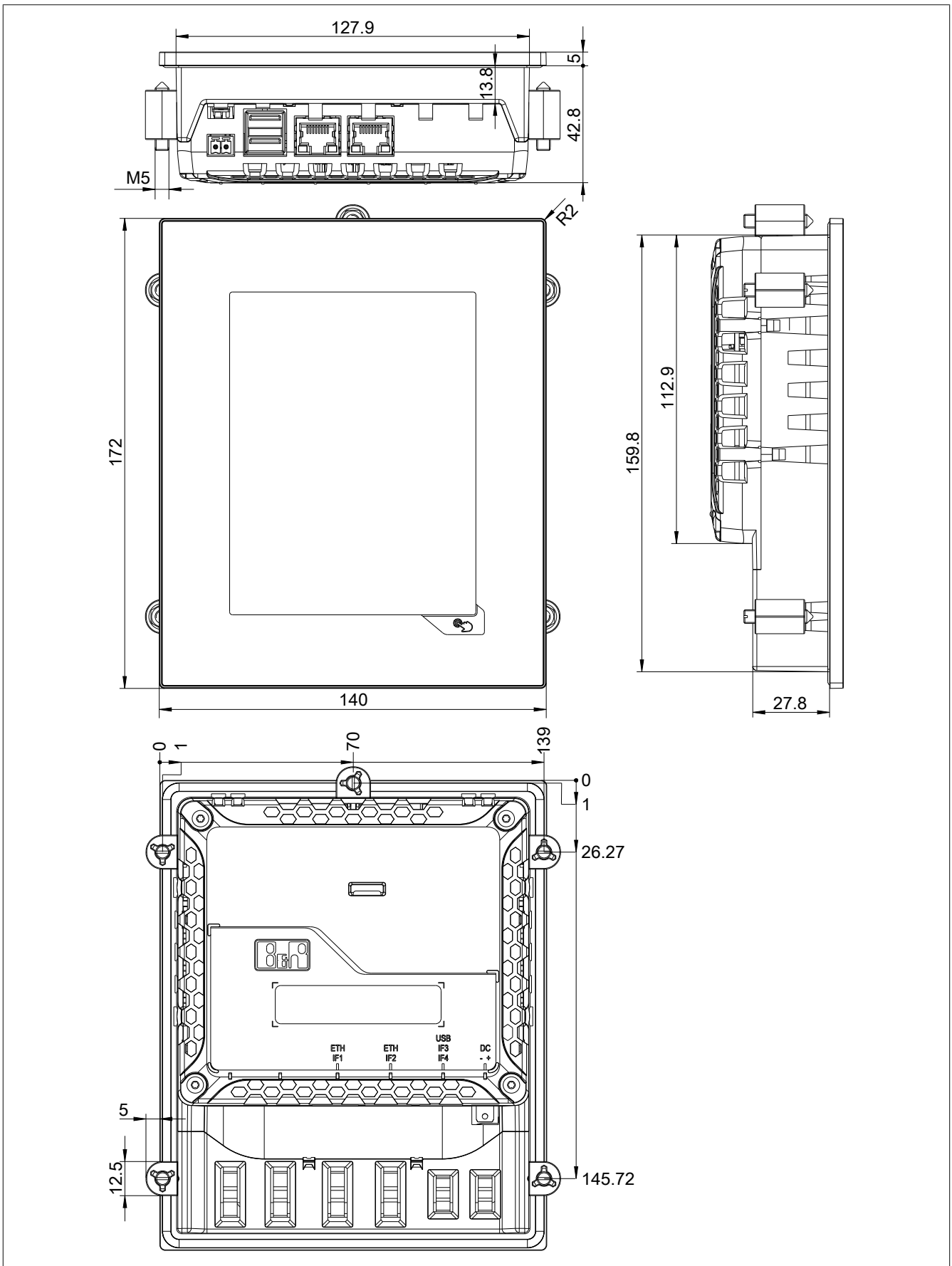

Figure 16: Dimensions - 6PPT30.057x-20x - 6PPT30.057L

Max. control cabinet thickness: 6 mm

Cutout dimensions: 129.9 mm ±1 x 161.8 mm ±1

2.4.8.3 Dimensions - 6PPT30.070x-20x

Landscape

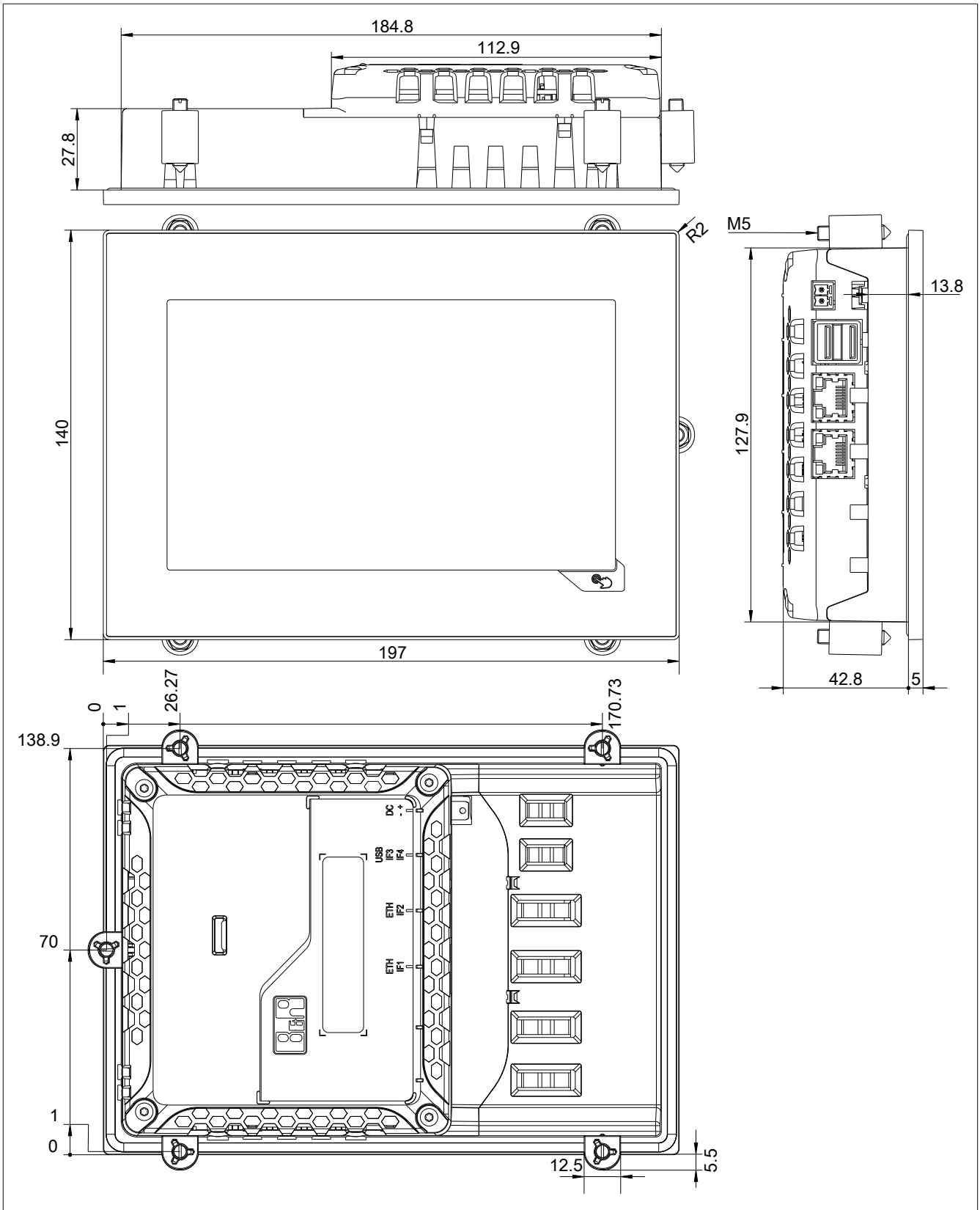

Figure 17: Dimensions - 6PPT30.070x-20x - 6PPT30.0702

Max. control cabinet thickness: 6 mm

Cutout dimensions: 186.8 mm \pm 1 x 129.8 mm \pm 1

Portrait

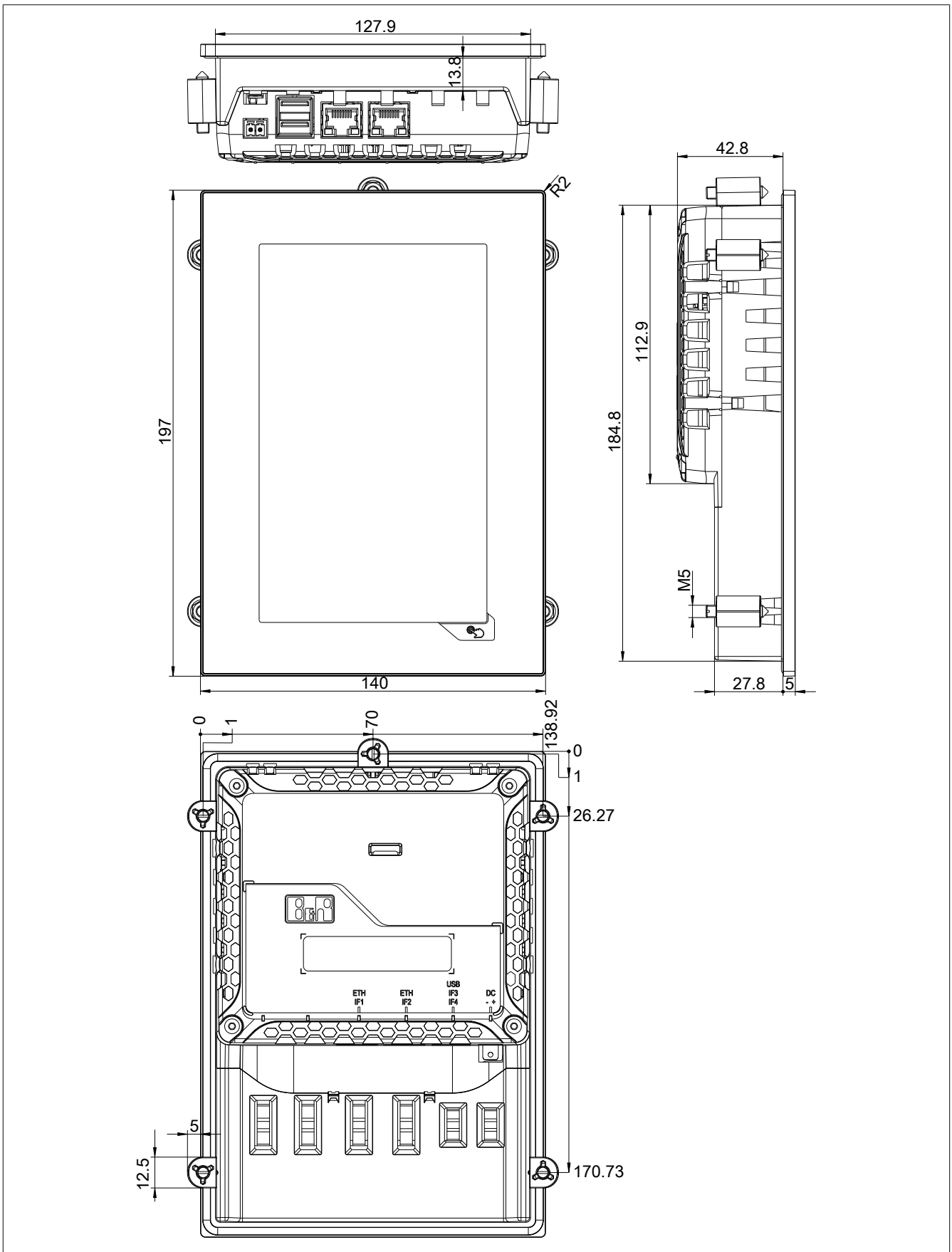

Figure 18: Dimensions - 6PPT30.070x-20x - 6PPT30.070M

Max. control cabinet thickness: 6 mm

Cutout dimensions: 129.8 mm ±1 x 186.8 mm ±1

2.4.8.4 Dimensions - 6PPT30.101x-20x

Landscape

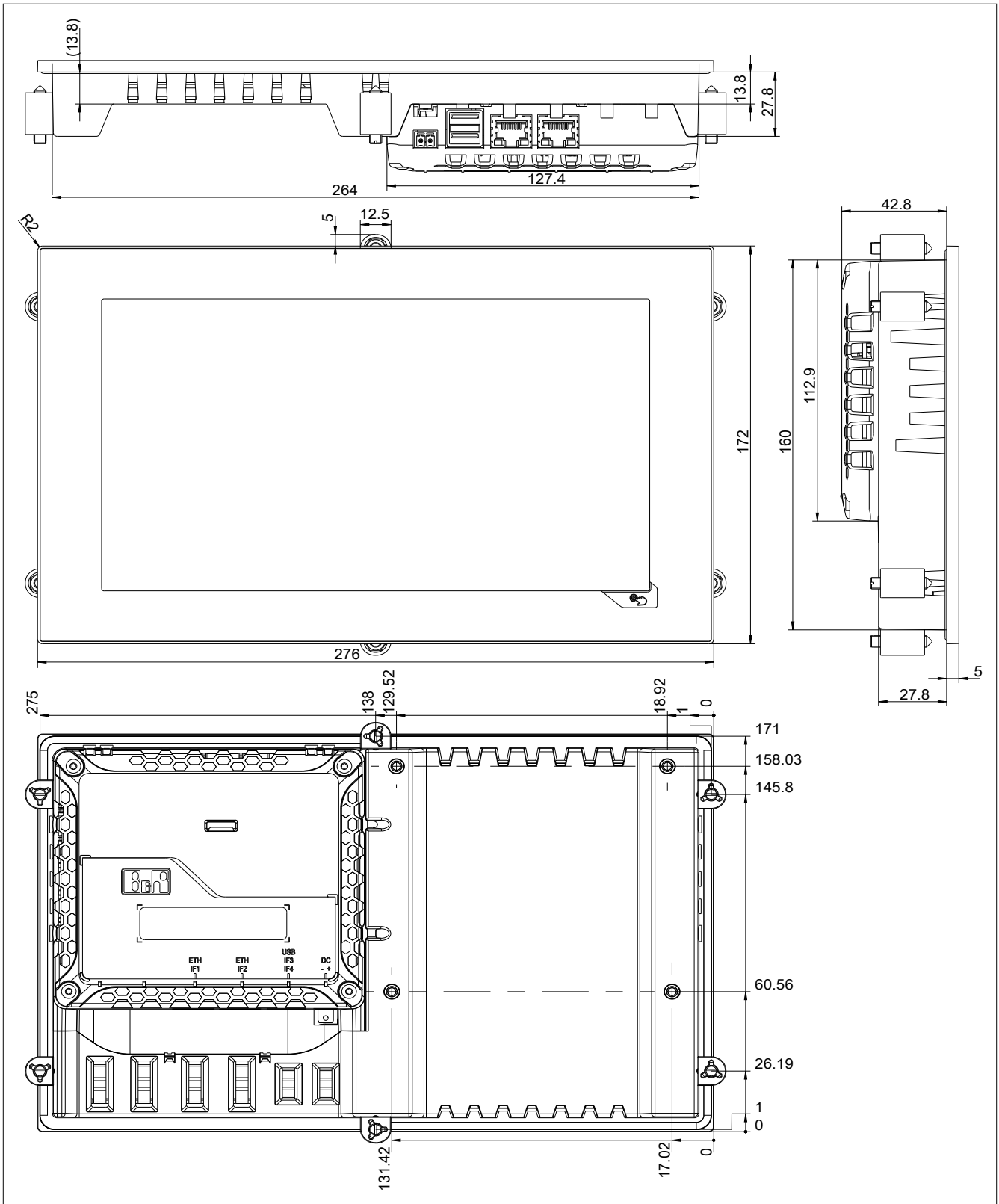

Figure 19: Dimensions - 6PPT30.101x-20x - 6PPT30.101G

Max. control cabinet thickness: 6 mm

Cutout dimensions: 265.9 mm ±1 x 161.9 mm ±1

Portrait

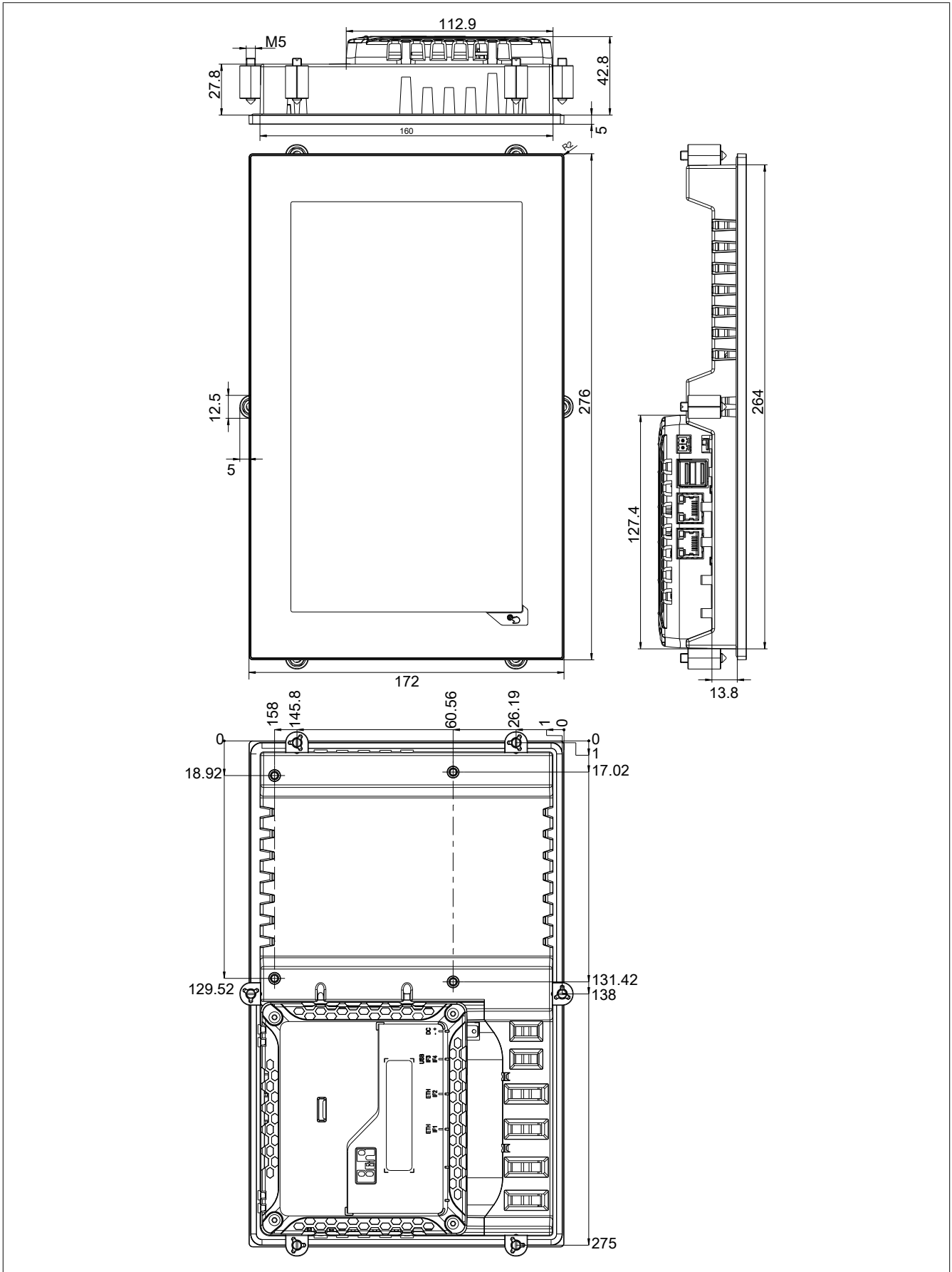

Figure 20: Dimensions - 6PPT30.101x-20x - 6PPT30.101N

Max. control cabinet thickness: 6 mm

Cutout dimensions: 161.9 mm ±1 x 265.9 mm ±1

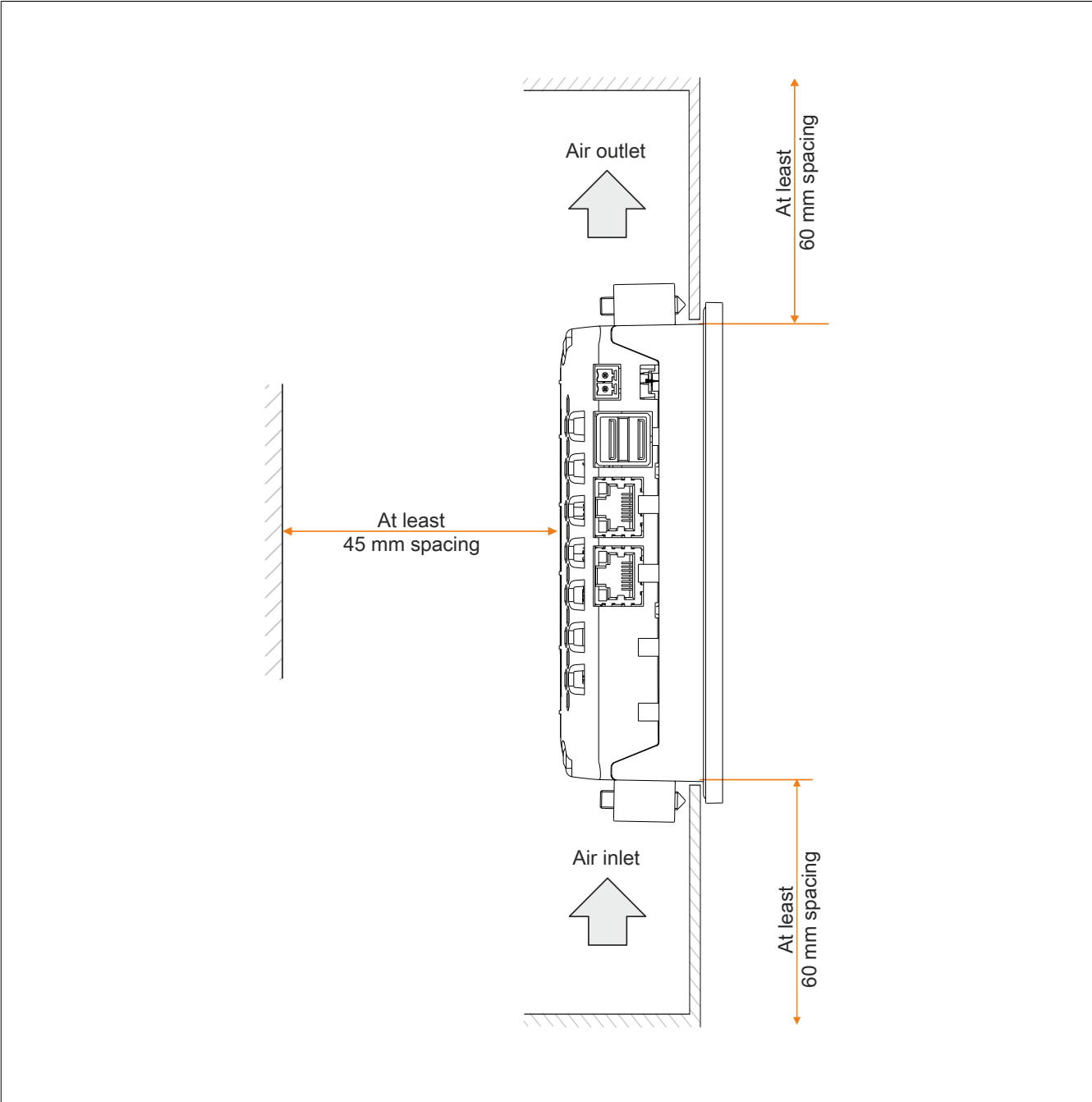

Figure 22: Spacing for air circulation - Side view

2 Mounting orientation

The following diagram displays the specified mounting orientation for the Power Panel. These mounting orientations apply to all Power Panel variants.

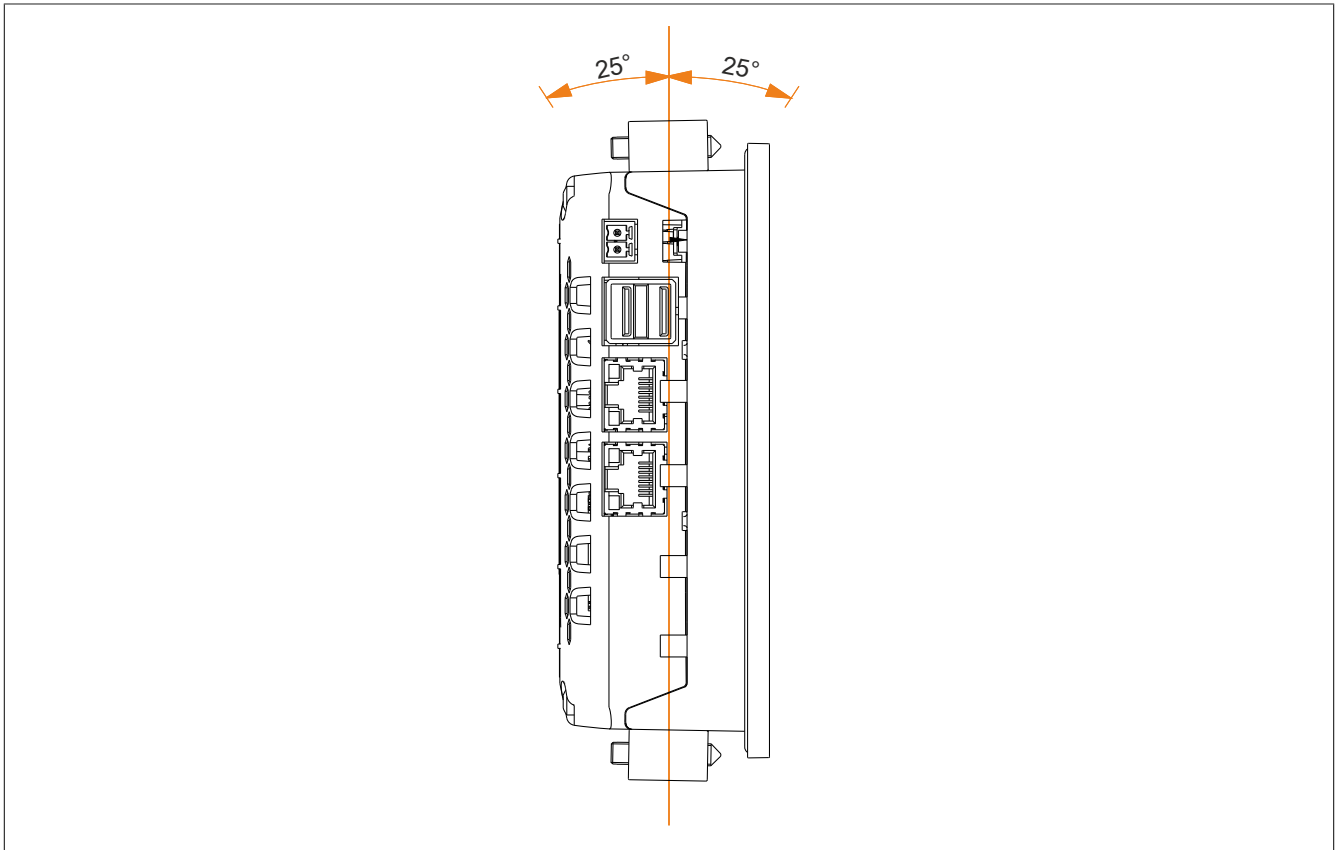

Figure 23: Power Panel - Mounting orientations

Caution!

The maximum permitted ambient temperature can be found in the technical data for the respective Power Panel.

3 Grounding

Grounding tongues on the circuit board ensure effective prevention of signal interference. The shielding of the various cables (Ethernet) is connected to the grounding plate.

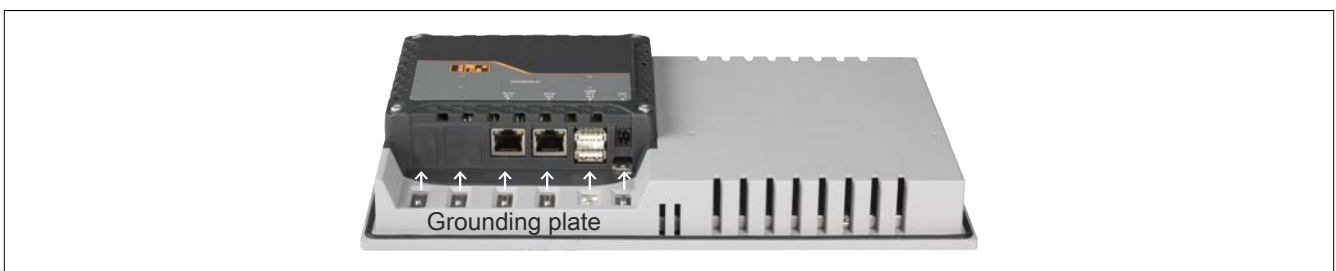

Figure 24: Grounding

Important!

The ground potential (which has a spade terminal) must be connected to ground (e.g. control cabinet) using the shortest possible path.



Figure 25: Grounding

4 Configuration - Possible operating modes

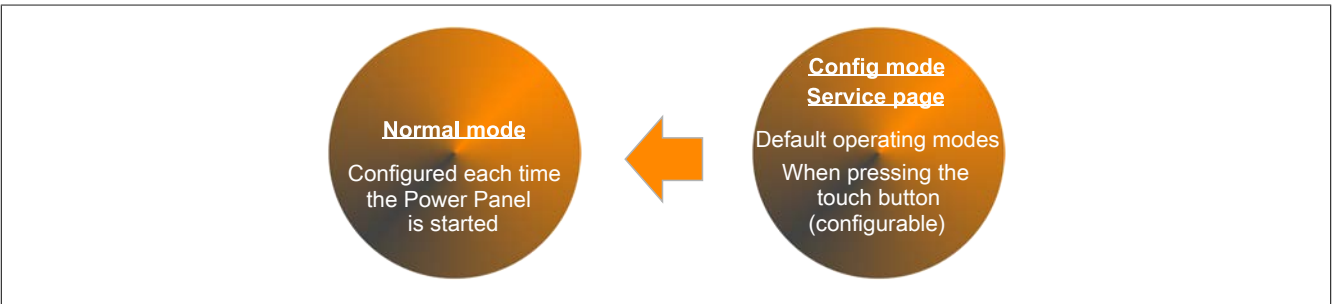

Figure 26: Configuration - Possible operating modes

5 Touch screen calibration

B&R touch screen devices are equipped with a touch controller that supports hardware calibration. As a result, devices are pre-calibrated when delivered. This is an advantageous feature when replacing devices of the same model or type since it avoids having to recalibrate the new device. Nevertheless, calibrating the device is still recommended in order to achieve the best results and to better adapt the touch screen to the user's preferences.

Chapter 4 • Standards and certifications

1 Applicable European directives

- EMC directive 89/336/EEC
- Low-voltage directive 73/23/EEC
- Machine directive 98/37/EC

2 Overview of standards

Standard	Description
IEC 61131-2	Programmable logic controllers - Part 2: Equipment requirements and tests
EN 61000-6-2	Electromagnetic compatibility (EMC) - Part 2 - Generic standards - Immunity for industrial environments
EN 61000-6-4	Electromagnetic compatibility (EMC) - Part 2 - Generic standards - Emission standard for industrial environments
EN 50581	Technical documentation for the assessment of electrical and electronic products with respect to the restriction of hazardous substances (RoHS)
EN 60529	Degrees of protection provided by enclosures (IP code)
GOST-R	Certificate of conformity for Russia

Table 21: Overview of standards

3 International certifications

B&R products and services comply with applicable standards. This includes international standards from organizations such as ISO, IEC and CENELEC, as well as national standards from organizations such as UL, CSA, VDE, ÖVE, etc. We are committed to ensuring the reliability of our products in an industrial environment.

Certifications	
Europe 	This mark certifies that all harmonized EN standards for the applicable directives have been met.

Table 22: International certifications

Chapter 5 • Accessories

1 T-Series overview

Model number	Product ID	6PPT30.043x-20x	6PPT30.057x-20x	6PPT30.070x-20x	6PPT30.101x-20x	Page
Cage clamp terminal block						
0TB6102.2110-01	Accessory 2-pin cage clamp (3.81)	•	•	•	•	44
Screw clamp terminal block						
0TB6102.2010-01	Accessory 2-pin screw clamp (3.81)	•	•	•	•	44
USB accessories						
5MMUSB.2048-01	USB 2.0 flash drive, 2048 MB, B&R	•	•	•	•	44
5MMUSB.4096-01	USB 2.0 flash drive, 4096 MB, B&R	•	•	•	•	
POWERLINK cable RJ45 to RJ45						
X20CA0E61.00020	PLK connection cable, RJ45 to RJ45, 0.20 m	•	•	•	•	44
X20CA0E61.00025	PLK connection cable, RJ45 to RJ45, 0.25 m	•	•	•	•	
X20CA0E61.00030	PLK connection cable, RJ45 to RJ45, 0.30 m	•	•	•	•	
X20CA0E61.00035	PLK connection cable, RJ45 to RJ45, 0.35 m	•	•	•	•	
X20CA0E61.00040	PLK connection cable, RJ45 to RJ45, 0.40 m	•	•	•	•	
X20CA0E61.00050	PLK connection cable, RJ45 to RJ45, 0.50 m	•	•	•	•	
X20CA0E61.00100	PLK connection cable RJ45 to RJ45, 1 m	•	•	•	•	
X20CA0E61.00150	PLK connection cable, RJ45 to RJ45, 1.50 m	•	•	•	•	
X20CA0E61.00200	PLK connection cable RJ45 to RJ45, 2 m	•	•	•	•	
X20CA0E61.00300	PLK connection cable RJ45 to RJ45, 3 m	•	•	•	•	
X20CA0E61.00500	PLK connection cable RJ45 to RJ45, 5 m	•	•	•	•	
X20CA0E61.00800	PLK connection cable RJ45 to RJ45, 8 m	•	•	•	•	
X20CA0E61.01000	PLK connection cable RJ45 to RJ45, 10 m	•	•	•	•	
X20CA0E61.01200	PLK connection cable RJ45 to RJ45, 12 m	•	•	•	•	
X20CA0E61.01500	PLK connection cable RJ45 to RJ45, 15 m	•	•	•	•	
X20CA0E61.02000	PLK connection cable RJ45 to RJ45, 20 m	•	•	•	•	
X20CA0E61.03000	PLK connection cable RJ45 to RJ45, 30 m	•	•	•	•	
X20CA0E61.05000	PLK connection cable RJ45 to RJ45, 50 m	•	•	•	•	
X20CA0E61.06000	PLK connection cable RJ45 to RJ45, 60 m	•	•	•	•	
POWERLINK cables, RJ45 to RJ45, can be used in cable drag chains						
X20CA3E61.0100	PLK connection cable, RJ45-RJ45, drag chain, 10 m	•	•	•	•	44
X20CA3E61.0150	PLK connection cable, RJ45-RJ45, drag chain, 15 m	•	•	•	•	
X20CA3E61.0200	PLK connection cable, RJ45-RJ45, drag chain, 0.20 m	•	•	•	•	
POWERLINK cables, RJ45 to M12						
X67CA0E41.0010	PLK attachment cable RJ45 to M12, 1 m	•	•	•	•	44
X67CA0E41.0050	PLK attachment cable RJ45 to M12, 5 m	•	•	•	•	
X67CA0E41.0150	PLK attachment cable RJ45 to M12, 15 m	•	•	•	•	
X67CA0E41.0500	PLK attachment cable RJ45 to M12, 50 m	•	•	•	•	
POWERLINK cables, RJ45 to M12, can be used in cable drag chains						
X67CA3E41.0150	PLK attachment cable RJ45-M12, drag chain, 15 m	•	•	•	•	44

Table 23: T-Series overview

2 TB102 2-pin power supply connector

This single-row 2-pin terminal block is used to connect the power supply.

2.1 Order data

Model number	Short description	Figure
	Terminal blocks	
0TB6102.2010-01	Accessory terminal block, 2-pin (3.81), screw clamp 1.5 mm ²	
0TB6102.2110-01	Accessory terminal block, 2-pin (3.81), cage clamp, 1.5 mm ²	

Table 24: 0TB6102.2010-01, 0TB6102.2110-01 - Order data

2.2 Technical data

Information:

The following characteristics, features and limit values only apply to this accessory and can deviate from those specified for the complete system. The data specifications for the complete system take precedence over those of individual components.

The technical data in this manual is current as of its creation/publication. We reserve the right to make changes.

Product ID	0TB6102.2010-01	0TB6102.2110-01
Terminal block		
Number of pins	2 (female)	
Type of terminal clamp	Screw clamps	Cage clamps
Cable type	Copper wires only (no aluminum wires!)	
Distance between contacts	3.81 mm	
Connection cross section		
AWG wire	28 to 16	
Wire end sleeves with plastic covering	0.25 to 0.5 mm ²	
With wire end sleeves	0.25 to 1.5 mm ²	
Flexible	0.14 to 1.5 mm ²	
Inflexible	0.14 to 1.5 mm ²	
Tightening torque	0.22 to 0.25 Nm	-
Electrical characteristics		
Nominal voltage	300 V	
Nominal current ¹⁾	8 A	

Table 25: 0TB6102.2010-01, 0TB6102.2110-01 - Technical data

1) The limit data for each Power Panel must be taken into consideration.

3 Data storage media

Technical data and additional information about data storage media can be found in the respective documentation. This can be found and downloaded under the model number of the data storage medium at www.br-automation.com.

4 Cable accessories

Technical data and additional information about POWERLINK and X2X Link cables can be found in the respective documentation. This can be found and downloaded under the model number of the cable on the B&R website at www.br-automation.com.

Chapter 6 • Maintenance

1 Cleaning

Danger!

Power Panels may only be cleaned when switched off in order to prevent unintended functions from being triggered when handling the touch screen or pressing keys.

Power Panels should be cleaned with a moist cloth. The cloth should be moistened with water and detergent, a screen cleaning agent or alcohol (ethanol). The cleaning agent should be applied to the cloth beforehand, not sprayed directly on the Power Panel! Aggressive solvents, chemicals, scouring agents, pressurized air or steam jets should never be used.

Information:

Displays with a touch screen should be cleaned regularly.

2 Screen burn-in on LCD/TFT monitors

Screen burn-in (afterimages, display memory effect, image retention or image sticking) occurs on LCD/TFT displays if a static image is displayed for a prolonged period of time. This static screen content causes the build-up of parasitic capacitances within the LCD components that prevent liquid crystal molecules from returning to their original state. This condition is unpredictable and can depend on the following factors:

- Type of image displayed
- Color composition of the image
- Length of time that the image is displayed
- Ambient temperature

Preventing screen burn-in

There is no perfect solution. There are ways to significantly reduce this effect, however:

- Avoid static images or screen content.
- Use non-static screensavers when the display is not in use.
- Frequent picture change
- Turn off the display when not in use.

Turning off the backlight does not help prevent screen burn-in.

Chapter 7 • Technical information

1 Panel membrane

The panel overlay conforms to DIN 42115 (Part 2). This means it is resistant to exposure to the following chemicals for a 24-hour period with no visible signs of damage:

Information:

The following characteristics, features and limit values only apply to this individual component and can deviate from those specified for the complete system. For the complete system in which this individual component is used, refer to the data given specifically for that device.

Ethanol cyclohexanol Diacetone alcohol Glycol Isopropanol Glycerine Methanol Triacetin Dowandol DRM/PM	Formaldehyde 37%-42% Acetaldehyde Aliphatic hydrocarbons Toluol Xylene White spirits	Trichloroethane Ethyl acetate Diethyl ether n-Butyl acetate Amyl acetate Butylcellosolve Ether
Acetone Methyl ethyl ketone Dioxan Cyclohexanone Methylisobutylketone (MIBK) Isophorone	Formic acid < 50% Acetic acid < 50% Phosphoric acid < 30% Hydrochloric acid < 36% Nitric acid < 10% Trichloroacetic acid < 50% Sulphuric acid < 10%	Sodium chloride <20% Hydrogen peroxide < 25% Potassium carbonate Washing agents Tenside Fabric conditioner Iron (II) chloride Iron (III) chloride Dibutyl phthalate Diocetyl phthalate Sodium carbonate
Ammonia < 40% Caustic soda < 40% Potassium hydroxide Alkali carbonate Bichromate Potassium Acetonitrile Sodium bisulphate	Cutting oil Diesel oil Linseed oil Paraffin oil Ricinus oil Silicon oil Turpentine oil substitute Brake fluid Aviation fuel Gasoline Water Sea water Decon	

Table 26: Chemical resistance of the panel overlay

The panel overlay conforms to DIN 42115 section 2 for exposure to glacial acetic acid for less than one hour without visible damage.

2 Viewing angles

Viewing angle specifications (R, L, U, D) for the display types are listed in the technical data for each device.

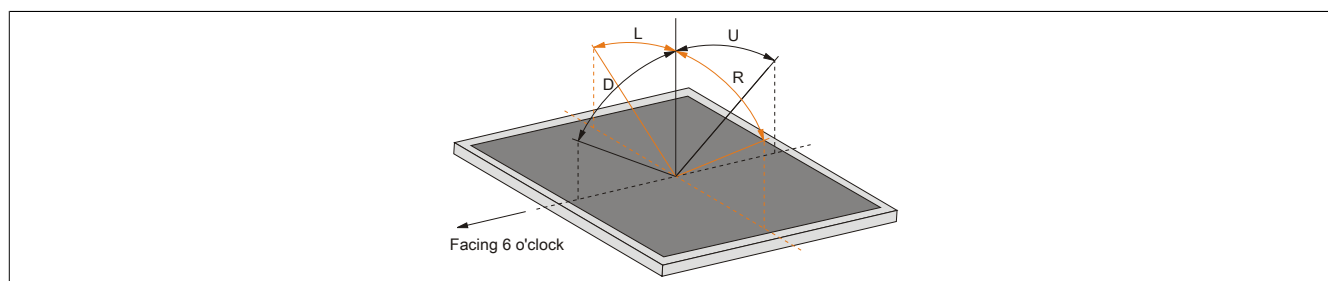

Figure 27: Viewing angles

Figure 1:	T-Series.....	7
Figure 2:	Power Panel T30.....	8
Figure 3:	Order number key.....	9
Figure 4:	Selecting a Power Panel.....	10
Figure 5:	Ethernet and POWERLINK LEDs.....	25
Figure 6:	6PPT30.043x-20x - Temperature/Humidity diagram.....	26
Figure 7:	6PPT30.057x-20x - Temperature/Humidity diagram.....	26
Figure 8:	6PPT30.070x-20x - Temperature/Humidity diagram.....	27
Figure 9:	6PPT30.101x-20x - Temperature/Humidity diagram.....	27
Figure 10:	USB port.....	28
Figure 11:	Power supply.....	29
Figure 12:	Grounding.....	29
Figure 13:	Dimensions - 6PPT30.043x-20x - 6PPT30.043F.....	30
Figure 14:	Dimensions - 6PPT30.043x-20x - 6PPT30.043K.....	31
Figure 15:	Dimensions - 6PPT30.057x-20x - 6PPT30.0573.....	32
Figure 16:	Dimensions - 6PPT30.057x-20x - 6PPT30.057L.....	33
Figure 17:	Dimensions - 6PPT30.070x-20x - 6PPT30.0702.....	34
Figure 18:	Dimensions - 6PPT30.070x-20x - 6PPT30.070M.....	35
Figure 19:	Dimensions - 6PPT30.101x-20x - 6PPT30.101G.....	36
Figure 20:	Dimensions - 6PPT30.101x-20x - 6PPT30.101N.....	37
Figure 21:	Spacing for air circulation - Rear view.....	38
Figure 22:	Spacing for air circulation - Side view.....	39
Figure 23:	Power Panel - Mounting orientations.....	40
Figure 24:	Grounding.....	40
Figure 25:	Grounding.....	41
Figure 26:	Configuration - Possible operating modes.....	41
Figure 27:	Viewing angles.....	46

Table 1:	Manual history.....	4
Table 2:	Organization of safety notices.....	6
Table 3:	Power Panel T-Series - General technical data.....	10
Table 4:	Overview - 6PPT30.043x.....	11
Table 5:	Overview - 6PPT30.057x.....	11
Table 6:	Overview - 6PPT30.070x.....	11
Table 7:	Overview - 6PPT30.101x.....	12
Table 8:	Interfaces.....	12
Table 9:	6PPT30.043F-20W, 6PPT30.043F-20B, 6PPT30.043K-20W, 6PPT30.043K-20B - Order data..	13
Table 10:	6PPT30.043F-20W, 6PPT30.043F-20B, 6PPT30.043K-20W, 6PPT30.043K-20B - Technical data.....	14
Table 11:	6PPT30.0573-20W, 6PPT30.0573-20B, 6PPT30.057L-20W, 6PPT30.057L-20B - Order data...	16
Table 12:	6PPT30.0573-20W, 6PPT30.0573-20B, 6PPT30.057L-20W, 6PPT30.057L-20B - Technical data.....	17
Table 13:	6PPT30.0702-20W, 6PPT30.0702-20B, 6PPT30.070M-20W, 6PPT30.070M-20B - Order data.	19
Table 14:	6PPT30.0702-20W, 6PPT30.0702-20B, 6PPT30.070M-20W, 6PPT30.070M-20B - Technical data.....	20
Table 15:	6PPT30.101G-20W, 6PPT30.101G-20B, 6PPT30.101N-20W, 6PPT30.101N-20B - Order data.	22
Table 16:	6PPT30.101G-20W, 6PPT30.101G-20B, 6PPT30.101N-20W, 6PPT30.101N-20B - Technical data.....	23
Table 17:	Ethernet LEDs.....	25
Table 18:	Ethernet interface - Pinout.....	28
Table 19:	USB port.....	28
Table 20:	Power supply.....	29
Table 21:	Overview of standards.....	42
Table 22:	International certifications.....	42
Table 23:	T-Series overview.....	43
Table 24:	0TB6102.2010-01, 0TB6102.2110-01 - Order data.....	44
Table 25:	0TB6102.2010-01, 0TB6102.2110-01 - Technical data.....	44
Table 26:	Chemical resistance of the panel overlay.....	46

0TB6102.2010-01.....	44
0TB6102.2110-01.....	44
6PPT30.043F-20B.....	13
6PPT30.043F-20W.....	13
6PPT30.043K-20B.....	13
6PPT30.043K-20W.....	13
6PPT30.0573-20B.....	16
6PPT30.0573-20W.....	16
6PPT30.057L-20B.....	16
6PPT30.057L-20W.....	16
6PPT30.0702-20B.....	19
6PPT30.0702-20W.....	19
6PPT30.070M-20B.....	19
6PPT30.070M-20W.....	19
6PPT30.101G-20B.....	22
6PPT30.101G-20W.....	22
6PPT30.101N-20B.....	22
6PPT30.101N-20W.....	22